

FieldSmart® FiberFlex 2000

Installation Manual



CLEARFIELD



FieldSmart® FiberFlex 2000

Installation Manual



Table of Contents	
About This Guide	5
Chapter 1: FiberFlex 2000 Product Overview	6
Cabinet Description	7
Cabinet Features	8
Cabinet Options	9
Cabinet Dimensions and Weights	10
Cabinet Views	11
Chapter 2: Installation Considerations	13
Installation Process Overview	14
Installation Guidelines	15
Space Requirements	16
General Safety Recommendations	17
Installation Kit	18
User-Supplied Items	19
Cabling Requirements	20
Chapter 3: Preparing the Installation Site	21
Installing a Ground Circuit	22
Constructing a Concrete Pad	25
Pad Construction Guidelines	25
Assembling the Cast-In-Place Template	28
Preparing the Site	29
Casting the Pad	30
Installing a Pre-Cast Concrete Pad	31
Pre-Cast Pad Requirements	31
Preparing the Site	34
Installing a Pre-Cast Pad	35
Installing a Foundation Vault	36
Foundation Vault Requirements	36
Preparing the Site	37
Installing the Foundation Vault	38



Chapter 4: Installing the Cabinet	39
Unpacking the Cabinet.....	40
Operating Cabinet Doors.....	41
Preparing the Cabinet for Installation.....	43
Installing the Cabinet on a Concrete Pad.....	44
Removing the Lifting Details.....	47
Chapter 5: Installing Local AC Power	48
Installing the Cabinet Ground Connection.....	49
Installing AC Power (220-240 VAC).....	51
Chapter 6: Installing Outside Plant Cables	53
Bonding Cable Sheaths.....	54
Installing Fiber Cable.....	55
Installing Outside Plant Fiber Cable.....	55
Splicing Fibers.....	56
Connecting Fibers to the Equipment.....	56
Sealing Cable Entry Locations.....	57
Chapter 7: Turning Up the Cabinet Power System	58
Turning Up the Power System.....	59
Checking the Ground Connection.....	59
Checking the AC Power Supply Voltage.....	60
Installing Rectifier Modules.....	61
Installing and Testing Batteries.....	62
Chapter 8: Installing Equipment, Options and Adding Capacity	70
Installing a Battery Compartment Riser.....	71
Installing a Battery Heater.....	72
Installing Fiber Splitters.....	78
FiberFlex 2000 Fiber Transport Module.....	81
Chapter 9: Cabinet Maintenance	82
Routine Maintenance.....	83
Checking Cabinet Surfaces.....	83
Checking Electrical Components.....	84
Checking Cable Connections.....	85

FieldSmart® FiberFlex 2000

Installation Manual



Checking the Heat Exchanger.....	86
Battery Maintenance.....	87
Replacing Parts and Equipment.....	89
Removing a Cabinet Door.....	89
Installing a Cabinet Door.....	90
Replacing the Cabinet Roof.....	92
Replacing AC Breakers.....	93
Replacing Rectifier Modules.....	94
Replacing Batteries.....	100
Replacing a Battery Heater.....	101
Appendix A: Reference Information.....	102
Specifications.....	103
Supported Batteries.....	104
Wiring Diagrams.....	104
Standard Warranty.....	105
Proprietary Notice.....	106
Technical Support.....	106



About This Guide

This document provides a general installation practice for the Clearfield FiberFlex 2000 outdoor cabinet. This document also provides a general description of the cabinet and its subsystems, guidance for planning, site preparation, power installation, splicing to the outside plant, component installation and expansion, and cabinet maintenance.

Intended Audiences

This document is intended for use by network planning engineers, outside plant engineers, field support personnel, and craft personnel responsible for cabinet installation, splicing, equipment installation, and maintenance.

Federal Communications Commission (FCC) Statement

This equipment has been tested and found to comply with the limits for a Class A digital device, pursuant to Part 15 of the FCC rules. These limits are designed to provide reasonable protection against harmful interference when the equipment is operated in a commercial environment. This equipment generates, uses, and can radiate radio frequency energy, and, if not installed and used in accordance with the instruction manual, may cause interference to radio communications. Operation of this equipment in a residential area may cause harmful interference; the user will be required to correct the interference at his expense.

Safety Notices

This document uses the following safety notice conventions.



DANGER! Danger indicates the presence of a hazard that will cause severe personal injury or death if not avoided.



WARNING! Danger indicates the presence of a hazard that will cause severe personal injury or death if not avoided.



CAUTION! Danger indicates the presence of a hazard that will cause severe personal injury or death if not avoided.



ALERT! Danger indicates the presence of a hazard that will cause severe personal injury or death if not avoided.



DANGER! CLASS 1 LASER PRODUCT. INVISIBLE LASER RADIATION MAY BE PRESENT
Danger indicates the presence of a hazard that will cause severe personal injury or death if not avoided.

Chapter 1: FiberFlex 2000 Product Overview

This chapter provides a general description of the Clearfield FiberFlex 2000 outdoor cabinet, including its standard features and options.

Topics Covered

This chapter provides a general description of the Clearfield FiberFlex 2000 outdoor cabinet, including its standard features and options.

- A description of the FiberFlex 2000 cabinet.
- A list of standard cabinet features.
- A list of cabinet options.
- Listed cabinet dimensions and weights
- A Views of the cabinet compartment.



Cabinet Description

The Clearfield FiberFlex 2000 cabinet is an environmentally-controlled outdoor enclosure designed to house and protect network electronics equipment. Use the FiberFlex 2000 to provide services from a remote node location deep inside the customer serving area, beyond the direct reach of the carrier Central Office.



The FiberFlex 2000 cabinet has a single compartment that houses active electronic equipment together with various fiber terminations, enabling deployment of multiple applications from one node. The electronics area is equipped with a 20 RU, 19-inch equipment rack providing flexible mounting space.

The FF2K supports local AC power configurations. The local power configuration includes an additional base compartment to support battery reserve power.

The modular design of the FF2K enables incremental expansion of system capacity, lowering initial deployment costs while maintaining the capacity for future growth. Modular components designed for expansion include compact service units, fiber management capacity, DC power modules, and cooling elements.

FieldSmart® FiberFlex 2000

Installation Manual



Cabinet Features

Standard features of the FiberFlex 2000 cabinet include:

Enclosure Design

- Environmentally sealed design protects from dust and water intrusion
- Designed to GR-487
- Environmentally rated from -40C to +46C (per GR-487 specifications)

Equipment Support

- 19-inch equipment rack provides 4 RU of mounting space
- Mechanical support for fiber terminations
- 20 RU
- Door-mounted 750W heat exchanger

Power (Local)

Standard features for the local power configuration include:

- 240 VAC load center (ETL-listed); 60 Amp capacity
- AC main/service disconnect breaker
- AC surge suppressor
- Duplex convenience outlet (GFCI protected)
- Fuse-protected DC supply to equipment
- Battery backup in separate vented compartment
- Up to 155 Ah battery reserve capacity (breaker-protected); up to 310 Ah capacity with second-string riser option



Cabinet Options

Common options for the FiberFlex 2000 cabinet include:

Enclosure Mounting

- Concrete pad mounting: pre-cast or site-cast pad (using Clearfield pad template)
- Foundation vault mounting (third-party supplied)

Fiber Management

- High density fiber management options (144 and 288 fiber distribution panels, 1:32 PON splitters, management accessories), up to 576 ports of internal distribution

Power

Local power support (commercial AC power supply); additional options include:

- 110/120 and 220/240 VAC input
- Generator connector (Hubbell); 30A NEMA twist lock with breaker

Battery Support (local power configurations)

- Northstar battery string and installation kit (OEM)
- Battery heater kit
- Battery compartment riser (supports second 155 Ah battery string)

FieldSmart® FiberFlex 2000

Installation Manual



Cabinet Dimensions and Weights

The external dimensions of the FiberFlex 2000 cabinet are shown below.

Dimension	Measurement (SAE)	Measurement (Metric)
Height	54 inches	137 cm
Width	24 inches	61 cm
Depth	35 inches	89 cm

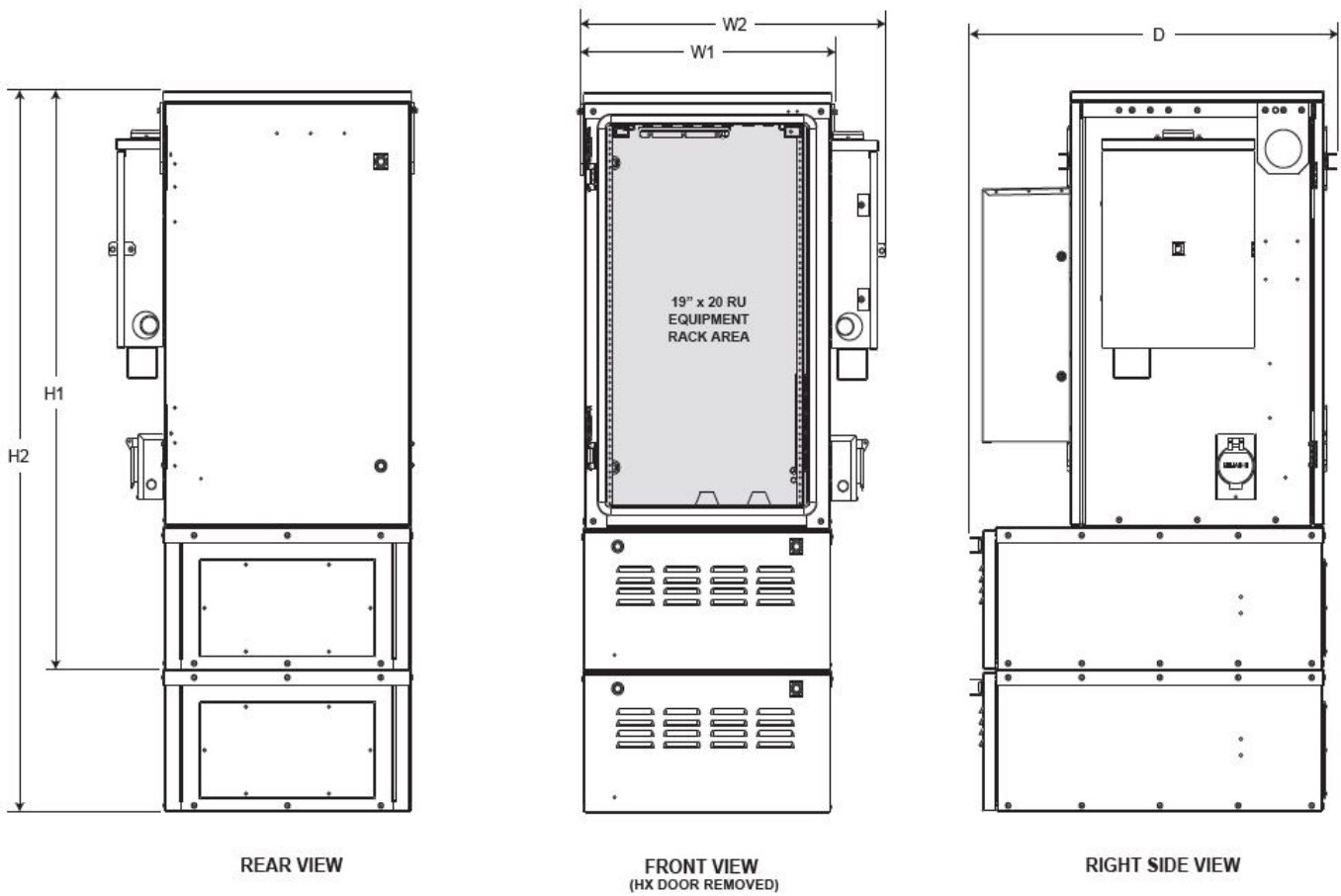

The approximate weight of the FiberFlex 2000 cabinet is shown below.

Configuration	Weight (SAE)	Weight (Metric)
FF2K (single string 155 Ah batteries)	222 lb	101 kg



Cabinet Views

Views of the FiberFlex 2000 cabinet follow.

Front Compartment

The front compartment provides access to the electronics equipment, cabinet power system, and fiber management. The cabinet power system consists of a side mounted AC load center option. For fiber access, the fiber management accessories may vary greatly according to the ordered options.

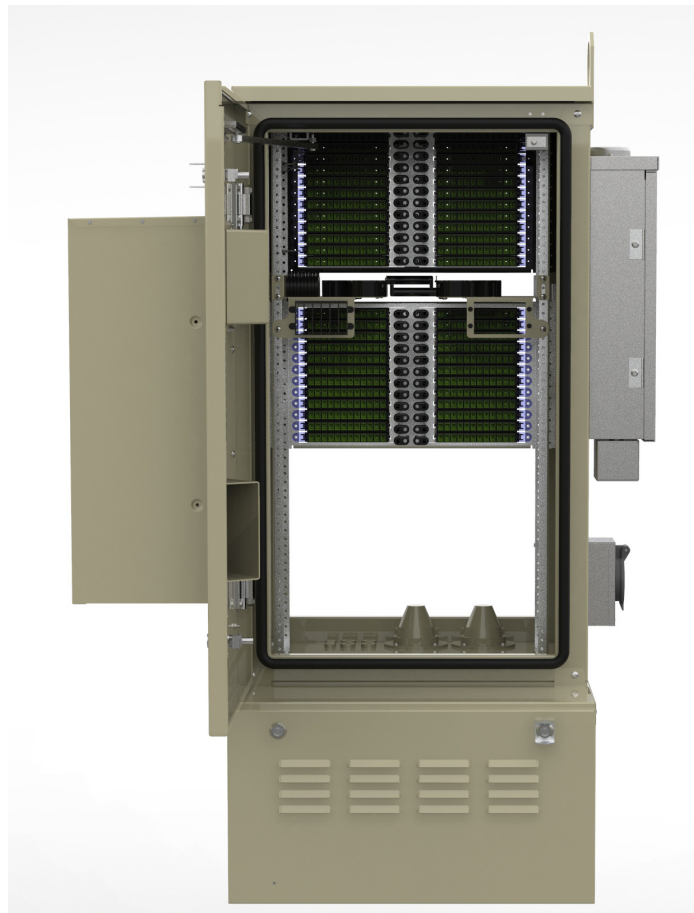

**FiberFlex 2000 Front
(local power)**



**FiberFlex 2000
Back**

Battery Compartment

Configured cabinets include a battery base compartment for housing one string of front-access VRLA batteries.

Battery compartment interior dimensions (for batteries): 11.3" (H) x 20.2" (W) x 21.5" (D)



Chapter 2: Installation Considerations

This chapter provides general considerations for cabinet installation. Review this information before starting the cabinet installation process.

Topics Covered

This chapter covers the following topics:

- Installation process overview
- Installation guidelines
- Space requirements
- General safety recommendations
- Installation kit contents
- User-supplied items
- Cabling requirements

Installation Process Overview

The cabinet installation process involves the following high-level steps:

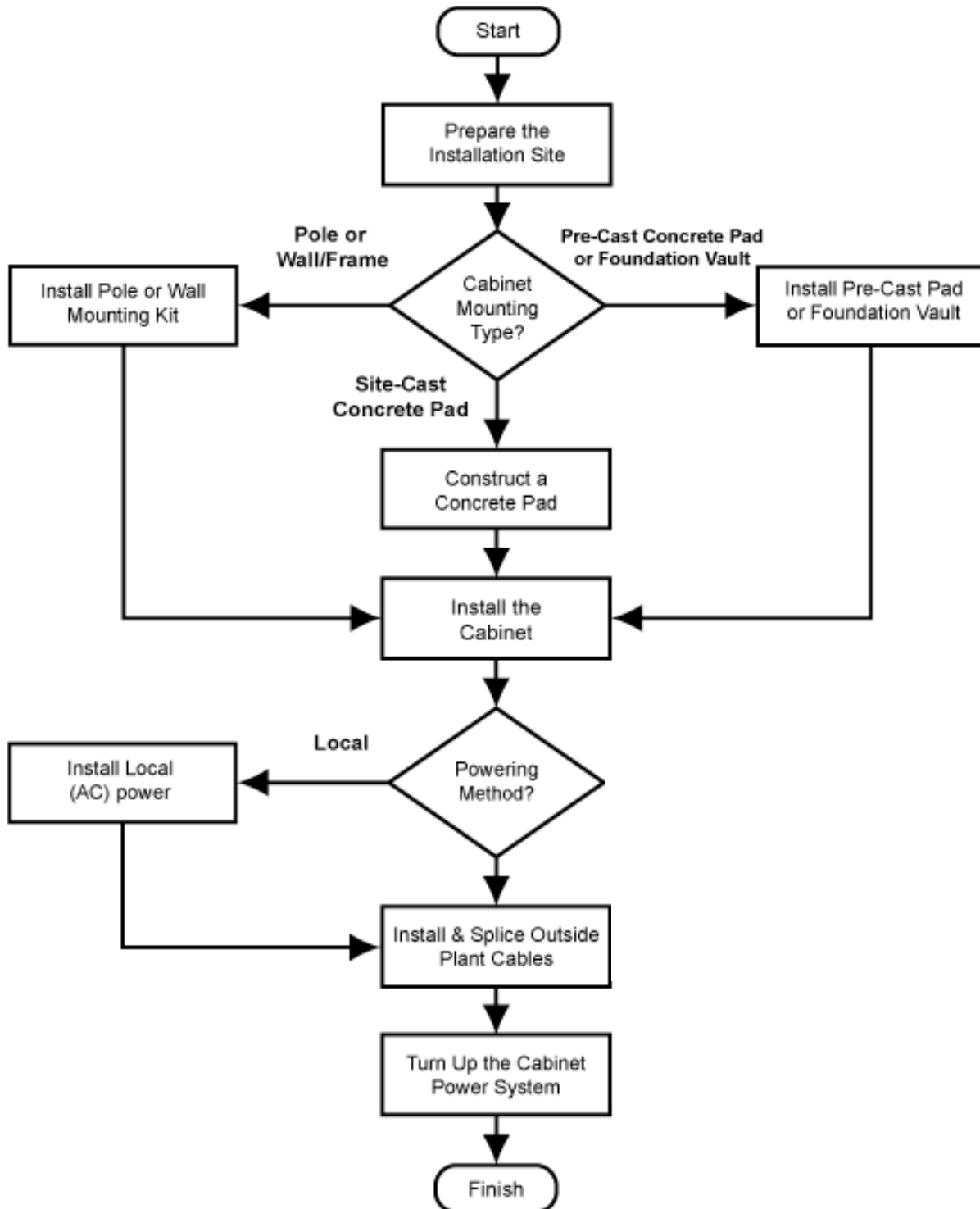



Installation Guidelines

Review the following guidelines before starting installation activities.

General Guidelines

Follow these general guidelines and practices:

- Read this document completely before starting any installation activities.
- Only qualified personnel should perform the procedures described in this document.
- Follow standard safety precautions when performing installation and maintenance tasks.
- Always wear standard safety gear when performing installation and maintenance tasks (hard hats/safety headgear, eye protection, insulated gloves).
- For safety, keep bystanders and other unauthorized personnel away from work operations at all times.
- Do not perform installation activities when the threat of lightning is present.
- **Warning!** - Seal all cable entry locations immediately after the cabinet is installed to prevent ground moisture from condensing inside the cabinet and damaging equipment.

Site Selection

The location of a cabinet installation site should be carefully planned in advance. Consider the following factors when selecting an installation site:

1. Functional requirements

- **Suitable terrain.** Whenever possible, the cabinet should be located in an area with a firm flat soil surface that does not require extensive earth work. The location should not be constantly damp or prone to flooding. Check soil maps of potential sites for subsurface conditions.
- **Grounding properties.** Grounding properties. The earth at the cabinet location should have a low ground impedance to provide an effective grounding system for lightning protection and safety. Perform ground testing to determine the grounding requirements.
- **Safety.** Whenever possible, the cabinet should be located on vacant property away from motor traffic to reduce injury risks to maintenance personnel or damage to equipment. On streets and highways, avoid locations near busy intersections or curves in the road. Erecting guard rails or concrete pillars can provide additional safety barriers against motor traffic.
- **Solar exposure.** Whenever possible in hot or warm climates, avoid locations with heavy exposure to direct afternoon sun, so as to maximize the life of electronics equipment in the cabinet. High outdoor temperatures and heavy solar exposure raise temperatures inside cabinets, a condition that can reduce the life span of equipment. Conversely, wind exposure improves thermal conditions in a cabinet, so locations that do not block wind are desirable.

2. Accessibility requirements:

- **Easement size.** Select a location with an easement that provides enough space to walk around the perimeter of the cabinet with its doors open.
- **Right-of-Way.** Secure a permanent location on private property, whenever possible. Obtain a firm right-of-way agreement that includes right of access. Avoid locations in public rights-of-way.
- **Electrical access.** Locally-powered cabinets must have access to commercial AC power. Verify the availability of AC service at potential cabinet locations.
- **Parking.** Whenever possible, the cabinet should be located in an area that provides sufficient parking space for installation and maintenance vehicles.

General Safety Recommendations



WARNING! Only trained, qualified technical personnel should perform the procedures described in this document. These procedures involve potentially hazardous activities, including handling of heavy equipment and exposure to high electrical energy, which could cause injury to untrained personnel.



DANGER! Risk of high power current surge and electric shock. Read and understand all power procedures before performing tasks. Take necessary precautions and use appropriate insulated tools when working with power. This equipment must be installed, operated, and serviced by qualified technical personnel only.



WARNING! The cabinet and its components are heavy. Handle with care to avoid personal injury or damage to the equipment.



DANGER! CLASS 1 LASER PRODUCT. INVISIBLE LASER RADIATION MAY BE PRESENT.

Fiber optic radiation can cause severe eye damage or blindness. Do not look into the open end of an optical fiber.



CAUTION! Batteries contain a stored charge. Handle batteries with care.



ESD ALERT! Beware of electrostatic discharge. Follow standard ESD precautions. Always wear a grounded ESD wristband to avoid damaging the electronic equipment.

FieldSmart® FiberFlex 2000

Installation Manual



Installation Kit

Clearfield supplies an installation kit with the cabinet that includes materials required for installation. The installation kit contents are listed below. Check to verify that your kit contains all of the listed items.:

<input checked="" type="checkbox"/>	Qty	Item Description
	1	Telco hex key, 5/16"
	1	Isolation mat
	4	Hex nuts (for mounting)
	8	Flat washers (for mounting)
	4	Split lock washers (for mounting)
	4	1/2" hex head bolts (for mounting)



User-Supplied Items

Supply the following items for cabinet installation.

Tools

Bring the following tools to the installation site:

- Power drill with universal socket and screwdriver bit sets
- Socket wrench/nut driver set (standard)
- Box wrench set (standard)
- Screwdriver set (standard)
- Beam Level
- Insulated needle-nose pliers
- Wire stripper
- Compression crimping tool
- Fiber cleaver
- Fiber splicer
- RB Razor-Sharp Cutting Edge knife, or another similar tool

Materials

Bring the following materials to the installation site:

- Leveling shims
- Silicone sealant
- Strain relief for #6-8 AWG wiring.

Equipment

Bring the following equipment to the installation site:

- Digital multi-meter
- Optical power meter
- Digital multi-function test set

FieldSmart® FiberFlex 2000

Installation Manual



Cabling Requirements

Cables supplied to the cabinet must meet the following minimum requirements.

Function	Facility	Requirements
Power		
Ground	Copper	6 AWG solid bare copper wire (to earth ground circuit); terminates to ground bar with screw lug
AC (local power)	Copper	8–10 AWG stranded copper; Follow National Electric Code (NEC) and local codes



Chapter 3: Preparing the Installation Site

This chapter describes how to prepare the installation site for cabinet placement, including establishing the cabinet mounting structure. You can install the cabinet onto a concrete foundation pad, a pole, or a foundation vault.

For pad-mount applications, you can construct a concrete pad using the Clearfield cast-in-place template or use a pre-cast concrete pad. A composite foundation vault, available from a third-party supplier, can provide easy under-cabinet access or serve as a riser.

For all mounting configurations, Clearfield requires installation of an earth ground circuit at the installation site to provide lightning protection.

Topics Covered

This chapter covers the following topics:

- Installing a ground circuit at the installation site
- Constructing a concrete pad
- Installing a pre-cast concrete pad
- Installing a pole mount kits
- Installing a wall mount kit
- Installing a composite foundation vault

Installing a Ground Circuit

Clearfield requires installing an earth ground circuit (earth electrode) at the installation site to provide protection from electric shock for equipment and personnel. The ground circuit may consist of a simple copper rod driven into the earth or a complex system of buried rods and wires. The lower the resistance of the electrode-to-earth connection, the more effective the ground system for safety and lightning protection.

Proper grounding conditions and requirements vary per site. The National Electric Code (NEC) specifies a maximum ground impedance of 25 ohms. Clearfield recommends achieving a ground impedance of no greater than 5 ohms wherever practical. If 5 ohms or less cannot be achieved, the maximum ground impedance should meet local codes or the NEC requirement of 25 ohms, whichever is less.

Grounding options

The cabinet main ground system must be bonded to a suitable earth ground circuit, which may include any of the following:

- **Ground rod(s):** A ground rod consists of a simple copper rod driven into the earth. A ground rod connects to the main cabinet or enclosure ground via an earth ground wire bonded to the ground rod and buried at the site. Multiple interconnected ground rods provide increased ground electrode-to-earth conductivity (ground grid). You can add supplemental ground rods to a single ground grid in several arrangements, including a linear chain, fan array, or ring configuration. Refer to the NEC or local regulations for restrictions and details. All bonds to grounding electrodes must be suitable for direct burial using irreversible mechanical connections or exothermic welds. Follow local code or site practice to satisfy any additional grounding requirements.
- **Ground ring:** A ground ring consists of multiple ground electrodes that encircle the perimeter of a site. Ground rings represent the preferred earth grounding system for cabinet deployments. Ground rings follow the NEC provisions for multiple ground electrodes.

Example of PANI-compliant ground ring with main site ground buss:

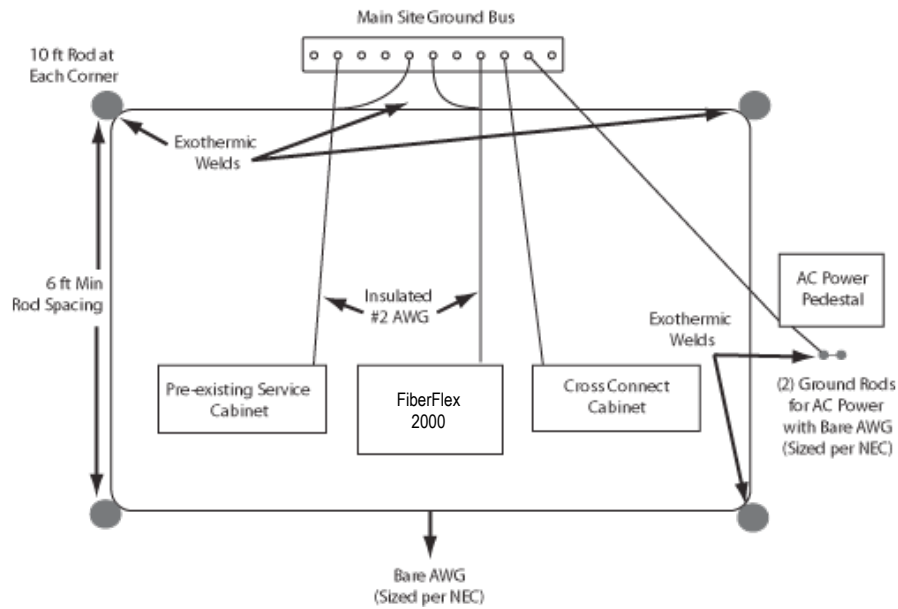

Example of PANI-compliant ground ring without a main site ground buss:

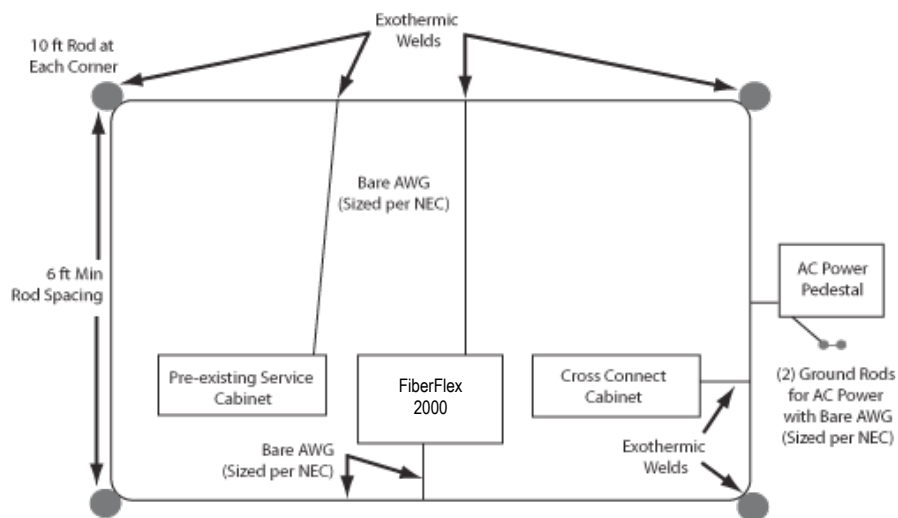

Ground Circuit Considerations

Following local codes and practices, install a ground circuit at the installation site. Consider the following factors when constructing the ground circuit:

- The ground electrode(s) should be copper-clad steel at least 5/8-inch in diameter.
- The ground rod or pipe electrode(s) should have a minimum of 8 feet of direct contact with earth.
- The wire connecting multiple electrodes should be bare copper sized per NEC, and should be buried at least 30 inches deep or below the frost line (whichever depth is greater).
- The wire connecting multiple electrodes should be connected with an exothermic weld or irreversible mechanical connector suitable for direct burial.
- The wire connecting the cabinet main ground bar to the initial ground electrode should be a 6 AWG or larger bare copper ground wire.
- The ground wire should enter the cabinet separated from power or copper transmission cables. Never bundle the ground wire together with other copper cables.
- Connect the ground wire to the main ground bar.
- Follow the PANI organization for all connections made to the equipment cabinet/enclosure ground bar as shown in Clearfield documentation.
- Measurements of the site ground circuit should be conducted to gauge achievement of 5 Ohms or less.

Note: You must install the cabinet's connection to the earth ground circuit before you connect commercial power to the cabinet.

Environmental factors

Environmental factors that may affect grounding conditions include:

- Type and size of an electrical surge; a lightning-induced current surge, voltage spike during an electrical storm, or static build-up from power utility lines may overwhelm the earth ground.
- Wet soil provides low resistance ground, with resistance increasing as the soil dries. Rock, gravel, sand, loam and clay react differently to wet/dry conditions.

Follow local code to satisfy additional requirements, if applicable.



Constructing a Concrete Pad

A concrete pad provides a permanent foundation to anchor the cabinet to the ground while protecting the cabinet from water damage and other outdoor surface conditions.

Construct a concrete foundation pad for the cabinet at the installation site. Pad construction requires excavating the site, trenching cable conduit, constructing a form, and casting concrete. Use the Clearfield -supplied cast-in-place template to provide exact locations for the mounting studs that anchor the cabinet to the pad and to provide the cable conduit locations.

Pad Construction Guidelines

When constructing a concrete pad, observe the following guidelines and refer to the pad drawings for guidance. Follow these guidelines to ensure proper pad construction. Adjust for local conditions or practices as required.

- Construct the pad with minimum perimeter dimensions of 42 x 48 inches.
- Construct the pad with a minimum height of 6 inches.
- Construct the pad with a maximum of 2 inches above-grade exposure.
- Use the Clearfield cast-in-place template to provide exact mounting stud and conduit locations.
- Use rebar or wire mesh inside the form to improve pad strength.
- Cast the pad from a single concrete pour. Do not make multiple pours.
- Ensure that the pad is smooth and level across its entire surface.
- Use 2.5-inch conduit (maximum) for outside plant cables. See drawing below for entry locations.
- Use 2-inch conduit (maximum) for AC cable (local power applications only). See drawing below for entry location.
- Include pull cords in all cable conduits.

Pad Drawings

Use the following drawings for reference during pad construction.

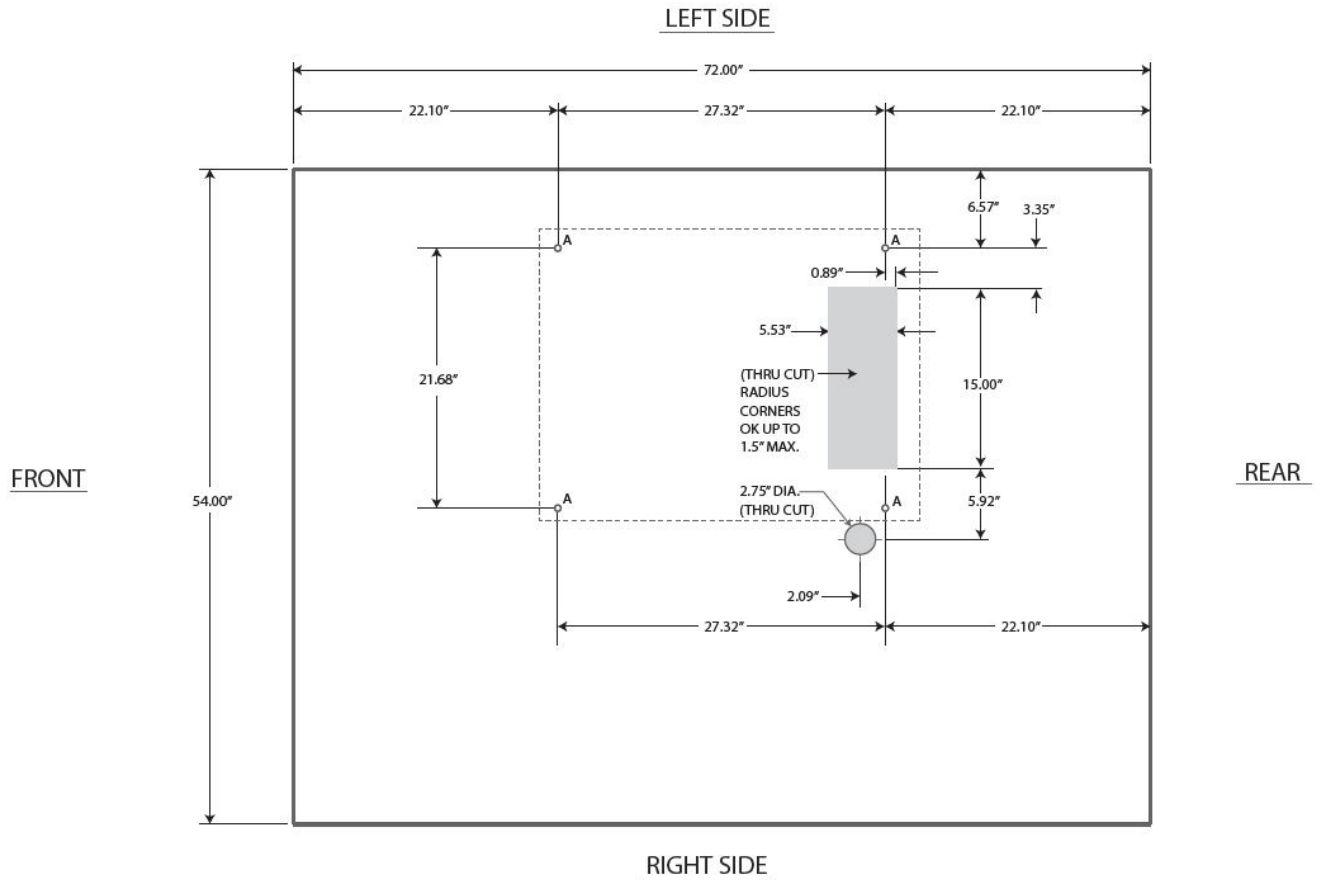

A = 1/2-13 Mounting Studs or Insert - Not to Exceed 1.5" protrusion above pad.

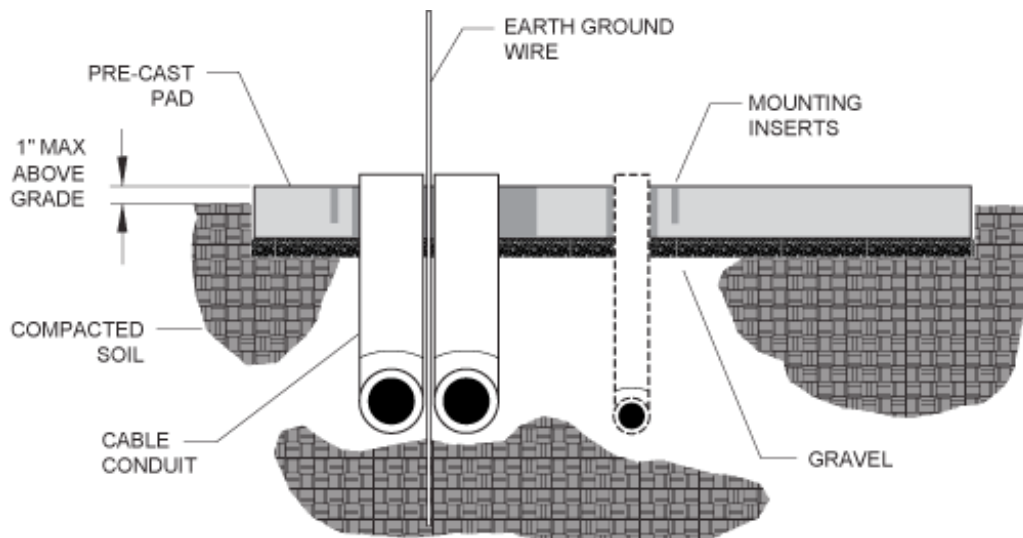

**Pad Cross-Section
(from left side)**

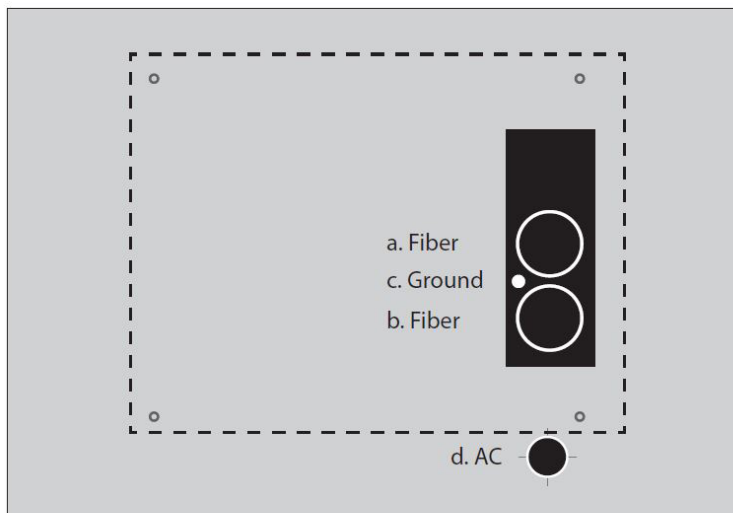

Conduit Locations

For proper cable entry into the cabinet, place conduit into the following locations.

- a. Conduit for outside plant cable (fiber).
- b. Conduit for outside plant cable (fiber).
- c. Earth ground wire
- d. Conduit for AC cable

Use the Clearfield cast-in-place template to provide precise conduit orientation.

Assembling the Cast-In-Place Template

Assemble the Clearfield cast-in-place template as follows.

To assemble the template

Step 1: Unpack the template hardware from the shipping kit.

Step 2: Place the four bracket members on the ground, arranged as follows:

- Place the two long brackets parallel with each other, flat side down.
- Place the two short brackets between (and perpendicular to) the long members, flat side down, with the conduit entry box bracket on the right.

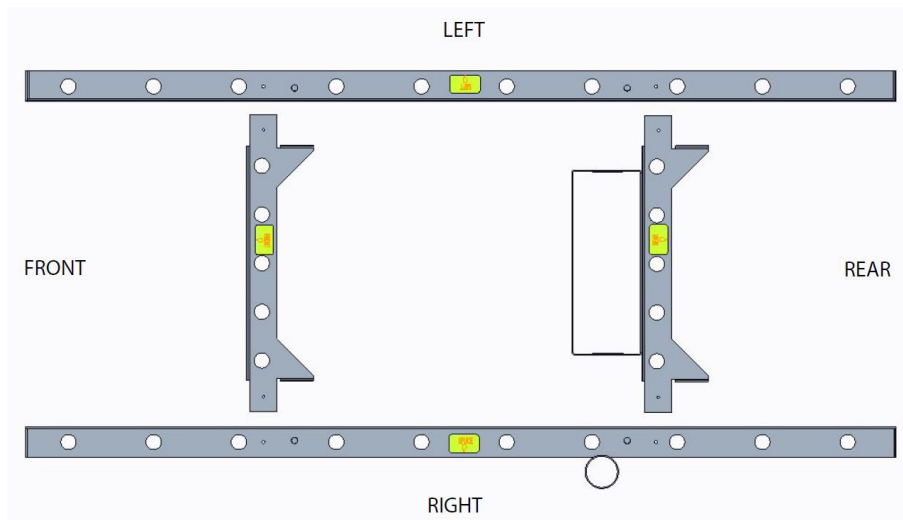

Step 4: Attach the short and long brackets together using the eight supplied screws, as shown.

Step 5: Tighten all screws to complete the template assembly.

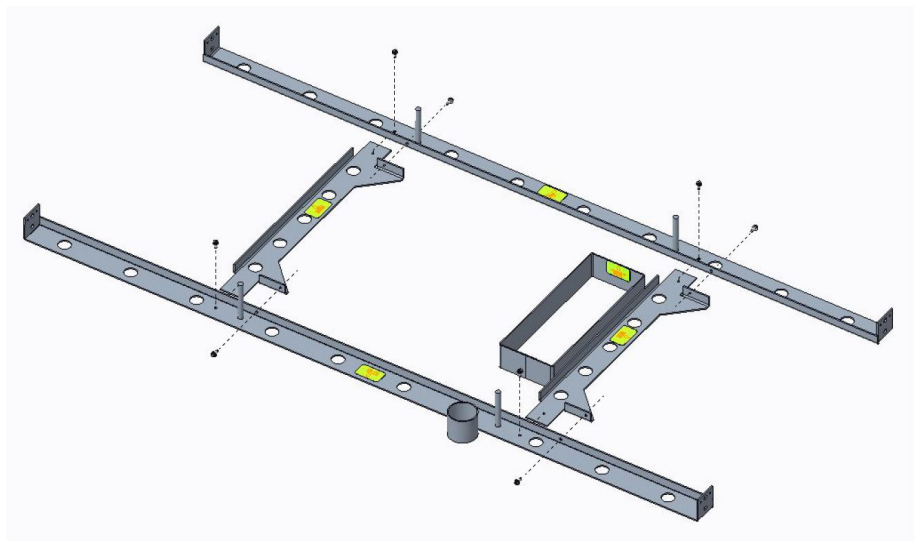



Preparing the Site

Prepare the site for pad construction as described below. Adapt the instructions as needed for local requirements, practices, or conditions.

To assemble the template

- Step 1:** Excavate the pad area. Dig a foundation hole six inches deep with a perimeter measuring at least 42 x 48 inches.
- Step 2:** Grade and compact the excavated surface until it is firm and level.
- Step 3:** Trench out conduit paths through the foundation hole from the cable feeder location. Refer to the pad drawings for conduit locations.
- Step 4:** Place the cable conduits into the conduit trench. Refer to the pad construction guidelines for conduit sizes and locations.
- Step 5:** Route the earth ground wire through the conduit trench (from the ground electrode).

To construct a concrete form

- Step 1:** Using 2 x 6 boards and stakes, construct a concrete form with interior dimensions of 42 x 48 inches inside the foundation hole. Make sure that the top edge of the form is level.
- Step 2:** Place gravel into the foundation hole to create a level base. The gravel layer should be at least two inches deep, compacted and leveled.
- Step 3:** Place and tie rebar inside the form elevated above the gravel.
- Step 4:** Place the Clearfield cast-in-place template into the form, guiding the cable conduits through the conduit entry ducts in the template.
- Step 5:** Align the template mounting brackets flush with the top of the form, then nail the template to the form to secure it in place.

Note: *The mounting studs should protrude approximately one inch above the form.*

- Step 6:** Verify that the form remains level across the entire surface. Adjust as required.
- Step 7:** Pull the earth ground wire (from the conduit trench) through the entry duct in the template, allowing at least three feet of wire to extend above the top of the form.
- Step 8:** Mask the four mounting studs on the template to protect the threads from concrete.

Casting the Pad

Cast the concrete foundation pad as described below. Adapt the instructions as needed for local requirements, practices, or conditions.

To cast the concrete pad

Step 1: Prepare the concrete mix. Be sure to mix enough concrete to cast the entire pad in a single pour.

Note: *To avoid structural weakening, do not cast a pad from multiple concrete pours.*

Step 2: Pour the concrete into the form. Do not allow the cast-in-place template to bend or twist out of shape during the pour.

Step 3: Smooth and level the top surface of the concrete.

Step 4: Leave the pad to cure. Do not remove the form until the concrete has fully cured (at least 72 hours). Perform the remaining steps only after the concrete has cured.

Step 5: Remove and discard the form.

Step 6: Backfill the cable conduit trenches with soil or gravel as required.

Step 7: Backfill and grade the perimeter area around the pad with soil, as required.

Step 8: Trim the cable conduits to a height no more than 4 inches above the pad.



Installing a Pre-Cast Concrete Pad

A concrete pad provides a permanent foundation to anchor the cabinet to the ground while protecting the cabinet from water damage and other outdoor surface conditions.

Install a pre-cast concrete pad for the cabinet at the installation site. Installation requires excavating the site, trenching cable conduit, creating a gravel foundation base, and placing the pre-cast pad on the foundation base.

Pre-cast pads ship configured with conduit entry cutouts and mounting fixtures (threaded inserts) for anchoring the cabinet to the pad. Specific features and dimensions vary by manufacturer. Contact your sales representative for a list of Clearfield-certified suppliers.

Pre-Cast Pad Requirements

When preparing for and installing a pre-cast concrete pad, observe the following guidelines. Refer to the pad drawings for guidance.

Guidelines

Follow these guidelines to ensure proper pad support for the cabinet. Adjust for local conditions or practices as required.

- Use a pad with a minimum height of 3 inches.
- Install the pad with a maximum of 1 inch above-grade exposure.
- Use 2.5-inch conduit (maximum) for outside plant cables. See drawing below for entry locations.
- Use 1-inch conduit (maximum) for AC cable (in local power applications only). See drawing below for entry location.
- Include pull cords in all cable conduits.

Refer to the pad manufacturer's instructions for additional guidelines.

Pad Drawings

Use the following drawings for reference during site preparation. Actual pad dimensions may vary by manufacturer. Refer to the manufacturer's documentation for more information.

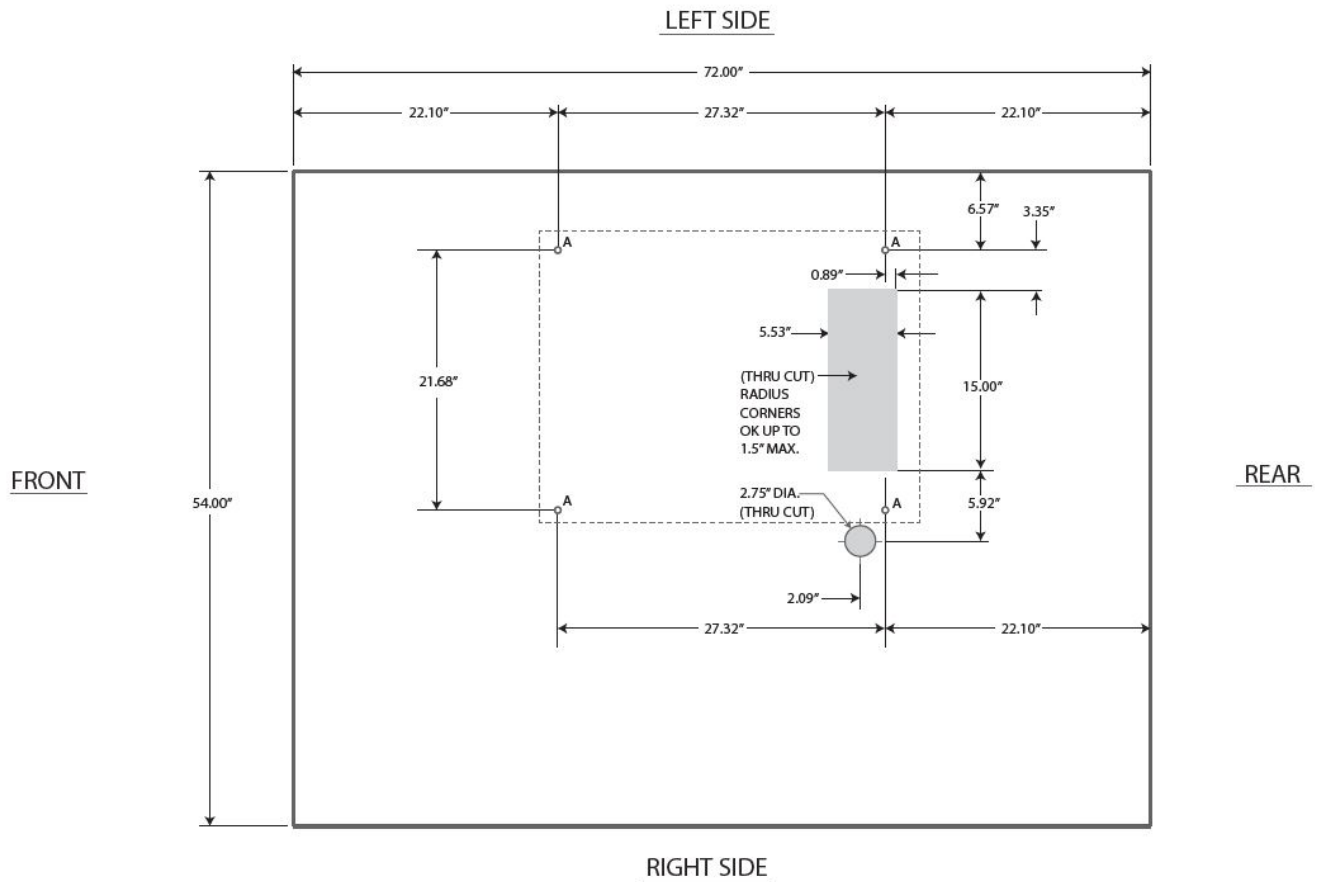

A = 1/2-13 Mounting Studs or Insert - Not to Exceed 1.5" protrusion above pad.

Pad Size

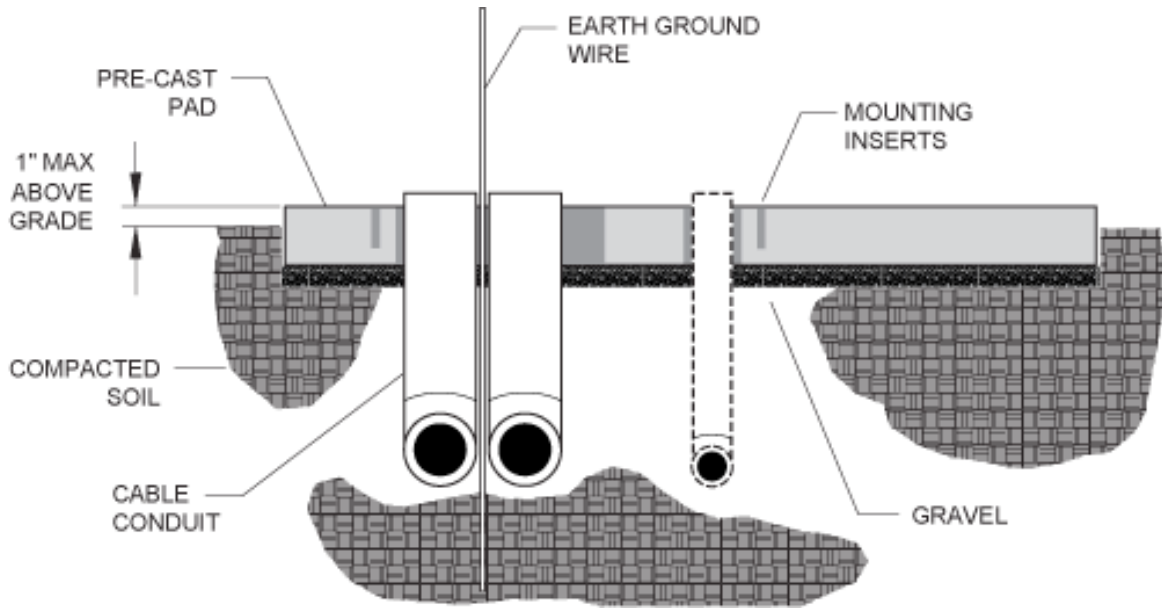

**Pad Cross-Section
(from left side)**

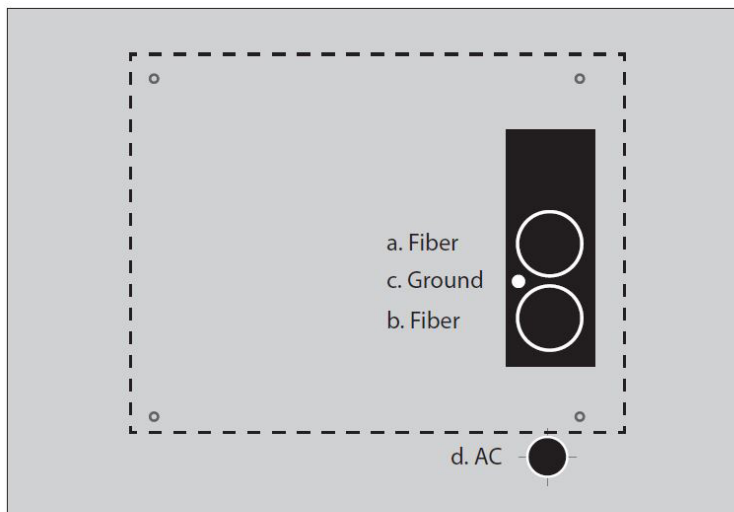

Conduit Locations

For proper cable entry into the cabinet, place conduit into the following locations.

- a.** Conduit for outside plant cable (fiber).
- b.** Conduit for outside plant cable (fiber).
- c.** Earth ground wire
- d.** Conduit for AC cable

Preparing the Site

Prepare the site for installation of a pre-cast pad. Some pads may require custom preparations. Refer to the manufacturer's instructions for more information.

A general practice is described below for reference. Adapt the instructions as needed for local requirements, practices, or conditions.



DANGER! Do not place outside plant cables into conduits at the pad site before installing the pre-cast pad. Attempting to install a pre-cast pad over existing cables becomes hazardous if a person must reach underneath a lowered pad to feed cables through its entry cutout.

To prepare the site for pad installation

- Step 1:** Excavate the pad area. Dig a foundation hole six inches deep with a perimeter measuring at least 54 x 74 inches.
- Step 2:** Grade and compact the excavated surface until it is firm and level.
- Step 3:** Trench out conduit paths through the foundation hole from the cable feeder location. Refer to the pad drawings for conduit locations.
- Step 4:** Place the cable conduits into the conduit trench. Refer to the pad guidelines for conduit sizes and locations.
- Step 5:** Route the earth ground wire through the conduit trench (from the ground electrode).
- Step 6:** Place gravel into the foundation hole to create a level base. The gravel layer should be at least two inches deep, compacted and leveled.

Note: *When installed, the pad should stand at least one inch above grade. Adjust the compaction and gravel depth accordingly, based on the pad height.*

Installing a Pre-Cast Pad

Install the pre-cast pad according to the manufacturer's instructions (typically supplied with the pad).

A general installation practice is described below for reference. Adapt the instructions as needed for local requirements, practices, or conditions.



WARNING! The pre-cast concrete pad is extremely heavy. Do not place any part of your body under the pad during lifting. Handle with care to avoid personal injury or damage to the pad.

To install a pre-cast pad

- Step 1:** Transport the pre-cast pad to installation site.
- Step 2:** Using a suitable lifting device (such as a backhoe equipped with lifting slings), lift the pad into position above the gravel base inside the foundation hole.
- Step 3:** Lower the pad onto the gravel base, allowing the conduits to pass through the cutout in the pad as it descends.
- Step 4:** Adjust the pad positioning on the gravel base until it is stable and level.
- Step 5:** Pull the earth ground wire through the cutout in the pad, allowing at least four feet of wire to extend above the top of the pad.
- Step 6:** Backfill and grade around the pad perimeter with soil to secure the pad in place.
- Step 7:** Verify that the pad remains level. Adjust as required.
- Step 8:** Trim the cable conduits to a height no more than 4 inches above the pad.

Installing a Foundation Vault

A foundation vault constructed of composite materials provides a flexible cabinet mounting option. Because foundation vaults stand approximately three feet tall, you can either bury the vault below ground to provide a pad-like mounting fixture with underneath access for maintenance and splice case storage, or you can install the vault above ground to serve as a riser in areas subject to heavy snow, mud, or flooding.

Installing a foundation vault requires excavating the installation site, trenching cable conduit, creating a gravel foundation base, and placing the vault on the foundation base.

Foundation vaults ship configured with knockouts for conduit entry and mounting fixtures (threaded inserts) for anchoring the cabinet to the top of the vault. Specific features and dimensions vary by manufacturer and model. Contact your sales representative for Clearfield -certified supplier information.

Foundation Vault Requirements

When preparing for and installing a foundation vault, observe the following guidelines. Refer to the vault drawings for guidance.

Guidelines

Follow these guidelines to ensure proper foundation support for the cabinet. Adjust for local conditions or practices as required.

- Foundation vaults have a typical height of 36 inches, the depth of which to bury can vary:
 - When serving as an above-ground riser, install the vault at least 6 inches below-grade (typical).
 - When serving as a pad-like fixture, install the vault with a minimum of 1 inch above-grade exposure (typical).
- Use 2.5-inch conduit (maximum) for outside plant cables. See drawing below for entry locations.
- Use 2-inch conduit (maximum) for AC cable. See drawing below for entry location.
- Include pull cords in all cable conduits.

Refer to the vault manufacturer's instructions for additional guidelines



Preparing the Site

Prepare the site for installation of a foundation vault. Some vaults may require custom preparations. Refer to the manufacturer's instructions for more information.

A general practice is described below for reference. Adapt the instructions as needed for local requirements, practices, or conditions.

To prepare the site for foundation vault installation

- Step 1:** Excavate the pad area. Dig a foundation hole to the required depth (six inches deep minimum), with a perimeter measuring at least 50 x 32 inches.
- Step 2:** Grade and compact the excavated surface until it is firm and level.
- Step 3:** Trench out conduit paths through the foundation hole from the cable feeder location.
- Step 4:** Place the cable conduits into the conduit trench. Refer to the vault guidelines for conduit sizes and locations.
- Step 5:** Route the earth ground wire through the conduit trench (from the ground electrode).
- Step 6:** Place gravel into the foundation hole to create a level base. The gravel layer should be at least one inch deep, compacted and leveled.

Installing the Foundation Vault

Install the foundation vault according to the manufacturer's instructions (typically supplied with the vault).

A general installation practice is described below for reference. Adapt the instructions as needed for local requirements, practices, or conditions.



WARNING! The foundation vault may be very heavy. Do not place any part of your body under the vault during lifting. Handle with care to avoid personal injury or damage to the vault.

To install a foundation vault

- Step 1:** Transport the foundation vault to installation site.
- Step 2:** Using a suitable lifting device, lift the vault into position above the foundation hole.
- Step 3:** Lower the pad onto the gravel base, making sure the conduits and earth ground wire pass inside the vault as it descends.
- Step 4:** Adjust the vault positioning on the gravel base until it is stable and level.
- Step 5:** Backfill and grade around the vault perimeter with soil to secure it in place.
- Step 6:** Verify that the vault remains level. Adjust as required.



Chapter 4: Installing the Cabinet

This chapter describes how to install the Clearfield FiberFlex 2000 cabinet onto its permanent mounting location.

Topics Covered

This chapter covers the following topics:

- Installing a ground circuit at the installation site
- Unpacking the cabinet from its shipping crate.
- Operating the cabinet doors.
- Preparing the cabinet for installation.
- Installing the cabinet onto a concrete pad
- Replacing the cabinet lifting detail brackets.

FieldSmart® FiberFlex 2000

Installation Manual



Unpacking the Cabinet

The cabinet ships from the factory on a wooden pallet and is enclosed in cardboard crating for protection. The cabinet is secured to the pallet by four bolts.

Do not remove the cabinet from the pallet until after it has been delivered to the installation site. However, you can remove the cardboard crating to inspect the cabinet at the staging area, if required. Clearfield recommends keeping the protective packaging in place for transportation.

When transporting the cabinet to the installation site, strap down the cabinet securely to the truck or trailer to prevent shifting or tipping. Unpack the cabinet at the installation site.

To unpack the cabinet

- Step 1:** After the cabinet has been delivered to the installation site, remove the cardboard packaging from the cabinet.
- Step 2:** Review the packing list to verify that all shipped materials are present.
- Step 3:** Discard the packaging material.
- Step 4:** Retrieve the telco hex key tied or taped to one of the cabinet doors.

Note: Use the supplied telco hex key to unlock the cabinet doors. See *Operating Cabinet Doors* for instructions.

Note: Do not remove the bolts securing the cabinet to the pallet until the cabinet is ready for placement.



Operating Cabinet Doors

Cabinet Doors

The cabinet has hinged front and side doors, each equipped with two telco hex-pin latches and a padlock hasp for security. Open and close doors using a Clearfield -supplied telco hex key.

Each door is equipped with an alarm switch that monitors the position of the door. When a door on an in-service cabinet is opened, an intrusion alarm reports through the equipment. Pull the switch plunger to disable the alarm reporting while you are working on the cabinet. The alarm switch is located at the upper right corner of the door frame.

To open a cabinet door

Step 1: Insert the telco hex key into the door's upper hex-pin latch.



Step 2: Turn the key counter-clockwise to disengage the latch.

Step 3: Repeat Steps 1 and 2 to disengage the lower latch.

Step 4: Swing the door open until the wind brace engages.

Step 5: On a powered cabinet, pull the alarm switch plunger to disable reporting of the intrusion alarm.



Note: Do not rotate the switch plunger. Rotating the plunger may damage the switch.

FieldSmart® FiberFlex 2000

Installation Manual



To close a cabinet door

- Step 1:** Push up on the wind brace to disengage it.
- Step 2:** Swing the door closed.
- Step 3:** Insert the telco hex key into the door's upper latch.
- Step 4:** While holding the door firmly closed, turn the key clockwise to engage the latch.
- Step 5:** Repeat Steps 3 and 4 to engage the lower latch.



Battery Compartment Door

The battery compartment door is secured at the top by a telco hex-pin latch, and it has a padlock hasp for security. Use a Clearfield -supplied telco hex key to open and close the door.

To open a battery compartment door

- Step 1:** Insert the telco hex key into the door's hex-pin latch.
- Step 2:** Turn the key counter-clockwise to disengage the latch.
- Step 3:** Tilt and pull the door panel forward, away from the cabinet.

To close a battery compartment door

- Step 1:** Insert the tabs on the back of the door onto the bottom lip of the door frame. Tilt and push the door panel closed.
- Step 2:** Insert the telco hex key into the door latch.
- Step 3:** While holding the door firmly closed, turn the key clockwise to engage the latch.



Preparing the Cabinet for Installation

Complete the following preparations before installing the cabinet.

To prepare the cabinet for installation

Step 1: Open the front and rear cabinet doors.

Step 2: From the battery compartment, remove the isolation mat and the bag containing the installation hardware. Set them aside for use during installation.

Step 3: Prepare the battery compartment as follows:

a. Remove the battery compartment door.

Step 4: Prepare the AC load center as follows:

a. Remove the four screws from the AC load center's front (breaker) panel, and then remove the panel from the load center housing. Retain the hardware for re-installation.

b. Loosen the coupling nut at the bottom of the housing to allow AC wires to pass into the load center.

Step 5: Remove the nuts from the four bolts securing the cabinet to the pallet:
The bolts are located at the bottom four corners of the battery compartment.

Step 6: If applicable, on the cable entry ducts, trim the rubber cone gaskets to the OSP cable diameter that will enter the cabinet (when installed). Be careful not to trim too much, as the gaskets should fit snugly around the cable. When the tasks above are complete, the cabinet is ready for installation.

Installing the Cabinet on a Concrete Pad

The cabinet is equipped with two lifting details on which to attach slings to lift and move the cabinet using a boom crane, derrick, or backhoe. Use wire rope slings and appropriately rated connecting links or lifting hooks. The lifting device and slings you use must be capable of lifting at least a 300 lb. working load. When using a lifting device to place the cabinet, follow these guidelines:

- Check the two lifting details on top of the cabinet to ensure that they are securely attached.
- Attach the lifting slings to the lifting device; attach the other sling ends to the cabinet lifting details with connecting links or hooks.
- Do not disconnect the slings from the cabinet until after it rests securely on the pad.



CAUTION! Installing the cabinet requires safe handling to ensure that no injury to personnel or damage to the cabinet occurs. Do not place any part of your body under the load during lifting. Follow local safety practices for lifting and moving heavy loads.



ALERT! Isolation mat usage is mandatory for concrete pad installations. Failure to use the supplied isolation mat can accelerate cabinet corrosion and may void the Clearfield cabinet warranty.

Before installing the cabinet, verify that the doors are locked in the open position (wind brace engaged). Verify that the battery compartment door and battery tray have been removed.

Note: *If you are installing the optional battery compartment riser to support a second 155 Ah battery string, install the riser onto the concrete pad first, and then mount the cabinet (with battery compartment) onto the riser. For detailed instructions on installing the cabinet onto the riser, see [Installing a 155 Ah Battery Compartment Riser](#).*



To install the cabinet (or riser) on a concrete pad

Note: The following procedure also applies to installing the optional battery compartment riser onto a concrete pad).

- Step 1:** Sweep the pad free of dirt and debris.
- Step 2:** Install the isolation mat onto the concrete pad.
- Step 3:** Using a lifting mechanism, lift the cabinet or battery compartment riser directly above its mounting position on the pad.
- Step 4:** Slowly lower the cabinet or riser onto the pad, keeping the mounting holes in the cabinet base aligned with the anchor studs (or holes) in the pad.

Note: If properly aligned, the entry ducts should slide down over the conduits as the cabinet or riser lowers. If necessary, trim the conduit down to a height that enables it to pass into the entry duct.

FieldSmart® FiberFlex 2000

Installation Manual



Step 5: Pull the earth ground wire into the cabinet or riser through one of the cable entry ducts.

Step 6: Anchor the cabinet or riser to the pad as follows:

Site-cast pads with anchor studs:

a. Get the four hex nuts, four flat washers, and four lock washers from the installation kit.

b. Install one flat washer, lock washer, and hex nut onto each of the four anchor studs.

c. Tighten the hex nuts to secure the cabinet or riser to the pad.

Pre-cast pads with threaded inserts:

a. Get four anchor bolts, four flat washers, and four lock washers from the installation kit.

b. Install one flat washer, lock washer, and anchor bolt into each of the four threaded mounting inserts.

c. Tighten the bolts to secure the cabinet or riser to the pad.

Step 7: Verify that the doors open and close freely. If necessary, use shims to level the cabinet or riser.

Step 8: Apply silicone caulking to the bottom perimeter of the cabinet or riser.

Removing the Lifting Details

After the cabinet is installed, remove the two lifting details from the cabinet.

To remove the lifting details

- Step 1:** Locate the two lifting details, attached to the upper left corners of the left and right sides of the cabinet.
- Step 2:** Remove the three bolts securing the first lifting detail to the cabinet.
- Step 3:** Remove and discard the lifting detail.
- Step 4:** Insert the three removed bolts back into the vacant bolt holes on the cabinet.

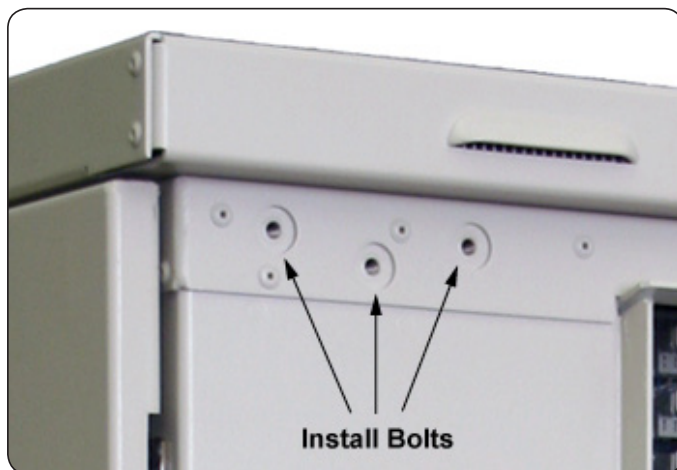

- Step 5:** Repeat Steps 2 through 4 to remove the other lifting detail.

Chapter 5: Installing Local AC Power

This chapter describes how to install AC local power to the cabinet.

- This process includes installing the cabinet earth ground connection and installing and wiring local AC power.

Install power according to your cabinet configuration type.

Topics Covered

This chapter covers the following topics:

- Installing the cabinet ground connection
- Installing local AC power



CLEARFIELD

FieldSmart® FiberFlex 2000 Installation Manual

Installing the Cabinet Ground Connection

You must install the cabinet's connection to the earth ground circuit before you connect commercial power to the cabinet.

Guidelines

Clearfield recommends adhering to PANI grounding methods to reduce ground current interaction:

- The PANI system divides the ground bar into sections, with one type of conductor in each section: Producers, surge Absorbers, Non-isolated and Isolated (PANI).
- The FiberFlex 2000 cabinet's main earth ground (that connects to the ground field) should bisect the main ground bar, effectively separating ground termination positions into two zones, as follows:
 - **Isolated Ground Zone (IGZ) 'equipment' grounds:** Active equipment ground terminations—as well as grounds for any DC power system(s), if collocated in the same enclosure—should be isolated from surge producing 'external' grounds.
 - **Surge producing 'external' grounds:** External interface ground connections (OSP cable sheath ground bonds, subscriber line protection panels, AC feeds, etc.) are considered surge producers and should be isolated from equipment grounds.
- The earth ground connection (middle position) on the FiberFlex 2000 cabinet ground bar serves as the primary surge absorber to isolate the equipment grounds from the surge-producing external grounds.

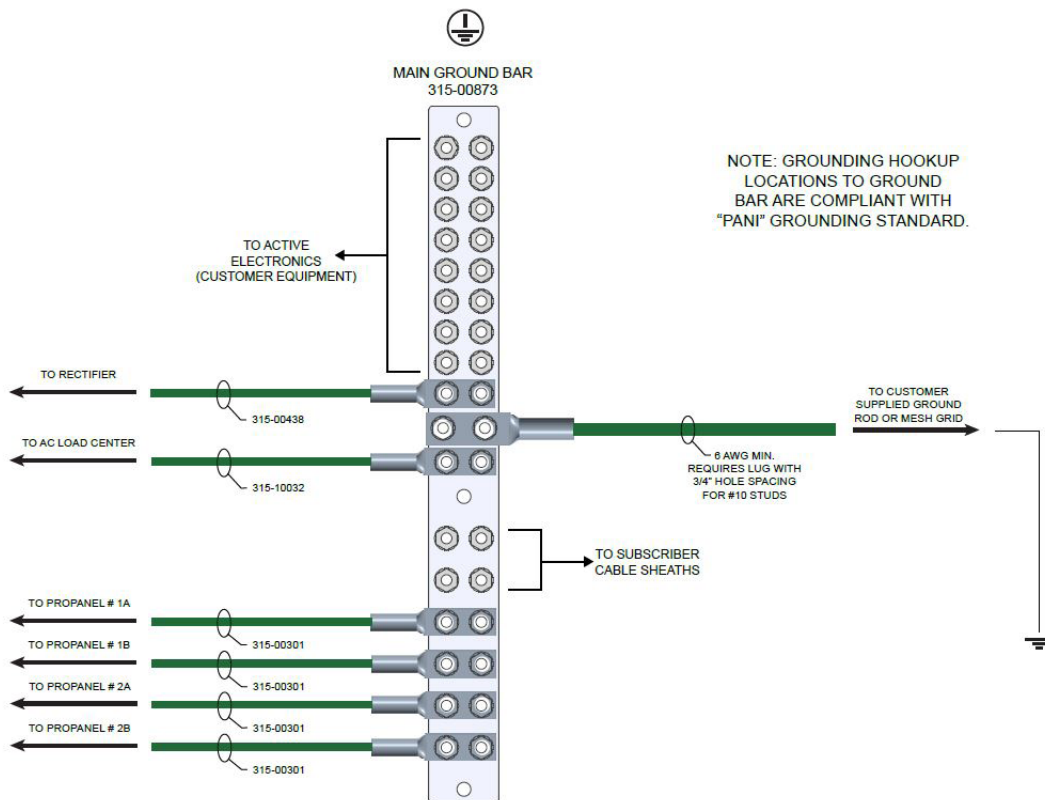

Note: Cabinet ground wiring diagrams are available at seecclearfield.com.

To install the cabinet ground connection

- Step 1:** Open the cabinet's side door.
- Step 2:** Route the earth ground wire to the main ground bar and cut the wire to length.
- Step 3:** Using a ratcheting crimp tool with embossing dies, attach a two-hole compression lug (#2– #6 AWG, 3/4-inch hole spacing) to the earth ground wire. Ensure that the correct lug is used to match the earth ground wire.
- Step 4:** At the middle of the ground bar, locate a ground position with 3/4-inch stud spacing. Remove the nuts from the identified terminal studs.
- Step 5:** Attach the earth ground wire's two-hole lug onto the 3/4-inch ground terminal studs per PANI guidelines.
- Step 6:** Re-connect the nuts to the ground terminal studs and tighten to 26 inch-lbs. of torque.

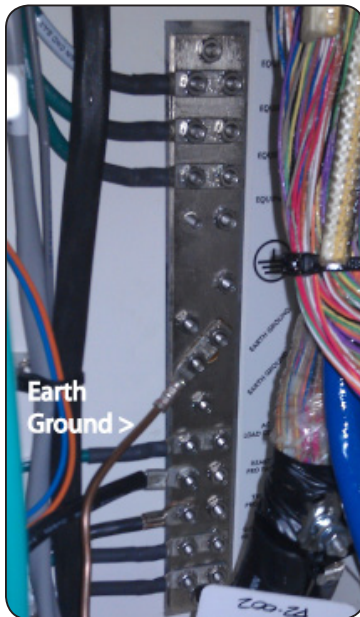

Installing AC Power (220-240 VAC)

Install 220-240 VAC power as described below.



DANGER! High voltage may be present. Risk of electrical shock. Do not apply AC power to the cabinet until the installation process is complete.



WARNING! Electrical hazard. Only a qualified electrician should perform this procedure.

Before proceeding, verify that AC service to the cabinet site is OFF at the local power transfer switch.

To install the cabinet ground connection

Step 1: Switch all AC load center breakers to the OFF position.

Step 2: If not done previously, prepare the AC load center for wiring as follows:

- a. Remove the AC load center's front (breaker) panel, and then remove the panel from the load center housing. Retain the hardware for re-installation.
- b. Loosen the coupling nut at the bottom of the housing to allow AC wires to pass into the load center.



FieldSmart® FiberFlex 2000

Installation Manual



- Step 3:** Install a user-supplied AC conduit into the load center. Install the conduit per local practice. Make sure the conduit is rated for AC cabling.
- Step 4:** Pull the AC wires (8–10 AWG) into the AC load center.
- Step 5:** Connect the AC wires to the load center according to the schematic
- Step 7:** Tighten the coupling nut around the AC wires at the bottom of the load center housing.
- Step 8:** Re-install the cover panel on the AC load center.



Chapter 6: Installing Outside Plant Cables

This chapter describes how to install outside plant cables into the cabinet, including fiber plant (fiber-optic cables for transport/uplink).

Topics Covered

This chapter covers the following topics:

- Installing fiber cables.
- Sealing cable entry locations.

Bonding Cable Sheaths

The optical cable sheaths must be bonded as follows:

- Bond the metallic sheaths of all optical cables to a grounding rod or system at their first appearance at the cabinet/enclosure site (at the copper pedestal or splice case, and so forth). If this point is close enough to bond to the cabinet/enclosure grounding system, bond to the same point on the main site ground bar (SPGP or equivalent) that the cross-connect bonds to.
- Bond the metallic sheaths of all optical cables to a grounding rod or system at regular intervals along the entire run external to the cabinet/enclosure site, per RUS guidelines.
- Clearfield recommends that you bond optical fiber cable sheaths at the first entrance to the cabinet/enclosure site only (the splice case, or similar), and then isolate the sheaths in the short run between splice point and the Clearfield equipment cabinet/enclosure ground. The short run can then be bonded on either side (the Clearfield ground bar side or splice point side, but not both) per local practice.



Installing Fiber Cable

This section describes how to install fiber optic cable into the cabinet, including how to route and groom the outside plant cable and splice fibers for terminating to the equipment.

Fiber management guidelines

When installing, splicing, and routing fibers in the cabinet, follow these guidelines:

- Avoid tight bend radii for fibers and provide adequate strain relief.
- Dress and secure fiber jumpers using Velcro straps or other soft-tie method designed for fiber. Avoid using plastic cable ties, which can damage a fiber.
- Label jumpers to simplify identification at splice and distribution locations.

Installing Outside Plant Fiber Cable

Install outside plant (OSP) fiber cable into the cabinet and prepare it for splicing. The following steps are general guidelines only. Follow local practice wherever applicable.

If the fiber splices will not reside in the cabinet (such as when located in an external splice case or fiber hand-hole), then adjust the installation procedure accordingly. In such cases, installation typically involves finished, individually jacketed fibers instead of OSP cable. Install this fiber per local practice.

To install outside plant fiber cable

- Step 1:** Open the cabinet's rear door.
- Step 2:** Trim the rubber cone gasket on the cable entry duct to the OSP cable diameter.
- Step 3:** Route the OSP fiber cable from the feeder location through the conduit and up into the cabinet.
- Step 4:** Pull the fiber cable up into the cabinet through the entry duct. Pull enough cable length to extend to the splice location.
- Step 5:** If splicing shall be performed at a later time, do the following:
- Using rope or cable ties, temporarily hang and secure the OSP cable inside the cabinet.
 - Make sure the cable arrangement allows the door to close. Take care to not violate the cable bend radius requirements.

The following steps are general guidelines only. Follow local practice where applicable.

Splicing Fibers

Note: If fiber splices will not reside in the cabinet, such as when using an external splice case or fiber hand-hole, skip this section. Splice fibers per local practice.

Note: For additional fiber management options, see *Installing Fiber Management Options*.

The following steps are general splicing guidelines only. Follow local practice wherever applicable.



DANGER! CLASS 1 LASER PRODUCT. INVISIBLE LASER RADIATION MAY BE PRESENT. High voltage may be present. Risk of electrical shock. Do not apply AC power to the cabinet until the installation process is complete.



CAUTION! Only a qualified technician should perform this procedure.

To splice fibers

- Step 1:** Open the cabinet's front door.
- Step 2:** If necessary, untie or cut any bindings temporarily securing the core fiber tubing near the splice tray.
- Step 3:** Remove the fiber splice tray from the cabinet wall.
- Step 4:** Assuming the bare fibers are stored inside the splice tray, remove enough fiber from the tray to perform splicing.
- Step 5:** Splice the fibers to fiber pigtails or jumpers per local practice.
- Step 6:** Neatly arrange the finished splices and slack fiber in the splice tray.
- Step 7:** Replace the splice tray into position on the cabinet wall.
- Step 8:** Dress any slack fiber from the pigtails or jumpers around the dressing assembly below the splice tray. Secure the fibers in place with a Velcro strap.

Connecting Fibers to the Equipment

Before you can connect fibers to the equipment, you must first install one or more pluggable transceiver modules into the optical Ethernet port sockets. If the laser at the far end is enabled, you can use an optical power meter to test the signal strength on the fibers before connecting to the equipment. Defer to local practice wherever applicable.



DANGER! CLASS 1 LASER PRODUCT. INVISIBLE LASER RADIATION MAY BE PRESENT. High voltage may be present. Risk of electrical shock. Do not apply AC power to the cabinet until the installation process is complete.

Sealing Cable Entry Locations

Seal the cable entry locations to protect the cabinet and riser against moisture, dust, pests, and other contaminants. Use a silicon-based sealant or comparable compound.



Warning! - Seal all cable entry locations immediately after the cabinet is installed to prevent ground moisture from condensing inside the cabinet and damaging equipment. Failure to take these preventive measures will void cabinet warranty.

To seal the cable entry locations

- Step 1:** Open the cabinet's rear door or battery compartment riser door.
- Step 2:** Adjust or trim the rubber cone gaskets on the cable entry ducts to create a tight seal around the cables, as required.
- Step 3:** If required, prepare the sealant for application per the manufacturer instructions.
- Step 4:** Apply the sealant around any open areas on the entry ducts where cables enter the cabinet or riser. Seal all gaps around the cables per the manufacturer instructions.

Note: Alternatively, you may invert the rubber cone gaskets and then inject a foam-type sealant into the cones around the cabling.



CAUTION! Only a qualified technician should perform this procedure.

Chapter 7: Turning Up the Cabinet Power System

This chapter describes how to turn up and test the cabinet power system.

This process includes checking the cabinet ground connection, checking the AC power supply voltage, installing rectifier modules into the rectifier shelf, installing batteries for reserve power, and turning up and testing the DC power system.

Topics Covered

This chapter covers the following topics:

- Turning up the cabinet power system (local power)



Turning Up the Power System

This section describes how to turn up and test the power system for locally-powered AC cabinets. The process includes checking the cabinet ground connection, checking the AC power supply voltage, installing batteries for reserve power, and turning up and testing the DC power system.

Topics Covered

This chapter covers the following topics:

- Checking the cabinet ground connection
- Checking the AC power supply voltage
- Installing rectifier modules into the Rectifier shelf
- Installing batteries for reserve power
- Turning up and testing the DC power system

Checking the Ground Connection

Check the impedance of the cabinet ground connection before turning up the cabinet power system.

Note: *The following procedure does not test the quality of the earth ground circuit (earth electrode), which should have been installed and tested before the cabinet was installed.*

To check the cabinet ground connection

Step 1: Using an ohm meter, test between the main ground bar and the earth ground wire:

- a. Place one lead on the main cabinet ground bar.
- b. Place the other lead on the earth ground wire.

Step 2: Verify that the ohm meter reads 5 ohms or less.

Step 3: If the reading is greater than 5 ohms, check the ground wire connection at the main ground bar, then retest.

Checking the AC Power Supply Voltage

The cabinet ships from the factory equipped to support 220-240 VAC service. Check the AC power supply voltage as follows.



DANGER! High voltage may be present. Only a qualified electrician should perform these procedures.

To check 220-240 VAC power supply voltage

Step 1: Apply AC power to the cabinet at the local power transfer switch.

Step 2: At the cabinet AC load center, do the following:

- a. Remove the front panel from the AC load center.
- b. Switch the Main breaker to ON.

Step 3: Using a volt meter, test between the L1 and neutral busses:

- a. Place one lead on the L1 buss.
- b. Place the other lead on the neutral buss.
- c. Verify that the volt meter reads between 110 and 120 VAC.

Step 4: Using a volt meter, test between the L2 and neutral busses:

- a. Place one lead on the L2 buss.
- b. Place the other lead on the neutral buss.
- c. Verify that the volt meter reads between 110 and 120 VAC

Step 5: Using a volt meter, test between the L1 and L2 busses.

- a. Place one lead on the L1 buss.
- b. Place the other lead on the L2 buss.
- c. Verify that the volt meter reads between 220 and 240 VAC.

Step 6: Switch the branch breakers on as follows:

- Switch the 15A Conv Outlet breaker to ON.
- If you are using an optional battery heater, switch the 15A Battery Heater breaker to ON.

Note: Do not switch on the Rectifier breaker at this time.

Step 7: Re-attach the front panel on the AC load center.

Installing Rectifier Modules

The FiberFlex 200 cabinet uses the 19-inch Eltek compact FPS rectifier shelf to generate and distribute -48 VDC bulk power. The Eltek FPS shelf supports up to two rectifier modules. Normal operation for the FiberFlex 200 cabinet requires two 20A rectifier modules.



Note: The far right slot does not support a rectifier module.

The Eltek FPS shelf provides integrated distribution, with 10 GMT fuse positions for equipment and one 40 Amp circuit breaker for batteries. The Eltek shelf is equipped with a Smartpack S controller module that monitors power functions and alarm information and regulates voltage in response to battery temperature. The controller module ships pre-programmed for operation in the FiberFlex 2000 cabinet.

Install Eltek rectifier modules into the shelf as described below.

Note: The controller module ships installed in the rectifier shelf. Push firmly on the controller module to verify that it is fully seated in the slot.

To install a rectifier module

- Step 1:** Unpack the rectifier module.
- Step 2:** Insert the rectifier module into the first or second vacant slot in the Eltek shelf. Populate slots from left to right (oriented vertically), leaving the third slot empty.
- Step 3:** Push firmly on the module to seat it in the slot.
- Step 4:** Repeat Steps 1–3 to install an additional rectifier module.

Installing and Testing Batteries

The cabinet can house a single string of front-terminal VRLA batteries (four batteries per string). A cabinet can also be equipped with an optional riser compartment to support a second battery string. See Supported Batteries for a list of supported battery types.

This topic provides instructions for the following tasks:

- Installing and testing a single string of 155 Ah batteries
- Installing and testing two strings of 155 Ah batteries (with optional second riser compartment)



WARNING! Electrical hazard. Batteries contain a stored charge. Only a qualified technician should perform this procedure.



CAUTION! Electrical, chemical, fire, and heat hazard. Handle batteries with care to avoid personal injury or damage to the equipment.



ALERT! Read the battery manufacturer's instructions before installing batteries. Follow the manufacturer guidelines and local safety practices.

To prepare batteries for installation

- Step 1:** Unpack the batteries from the shipping packaging.
- Step 2:** Remove the terminal caps from the top of each battery.
- Step 3:** Clean and apply No-Ox anti-corrosion grease to each battery terminal.
- Step 4:** Locate the bagged kit containing the string jumper straps and other materials. Set the kit aside for use during installation.

Note: *If the batteries are not fully charged, perform these procedures after charging the batteries.*



WARNING! In -48V telecom systems, red leads connect to the negative terminal and black leads connect to the positive terminal. Do not reverse the wiring polarities.

To install a single string of 155 Ah batteries

Note: If you plan to install a second battery string in the riser compartment, go to the next procedure. If you do not plan to install a second battery string, locate the Anderson connector for the second battery string and disconnect if required.

Step 1: At the rectifier shelf, open the fuse panel door. Verify that the battery breaker is OFF.

Step 2: Remove the battery compartment door. See Operating Cabinet Doors for instructions.

Step 3: Remove the front retainer bracket from the battery tray.

Note: If you are using the optional battery heater, install the heater before installing batteries. See Installing a Battery Heater for instructions.

Step 4: In the battery compartment, disconnect the #8 AWG battery power cables from the power supply leads and set the cables aside.

Step 5: Place a string of four batteries partially into the battery compartment, arranged with the terminals accessible in front.

Note: You will slide the batteries into the battery tray after installing the cables and protective covers.

Step 6: Connect the battery power cables as follows:

- a. Remove the protective caps from the cable ring lugs.
- b. Attach the black cable to the positive (+) terminal post at the positive end of the string.
- c. Attach the red cable to the negative (-) terminal post at the negative end of the string.

ALERT! Check all connections carefully to verify correct wiring polarities.

- d. Install the temperature sensor cable lug onto the string's negative (-) terminal post.
- e. Tighten the hardware on the terminal posts to the torque specified by the manufacturer.

Step 7: Install the three jumper cables between the battery terminal posts using the supplied flat washers, split lock washers, and bolts.

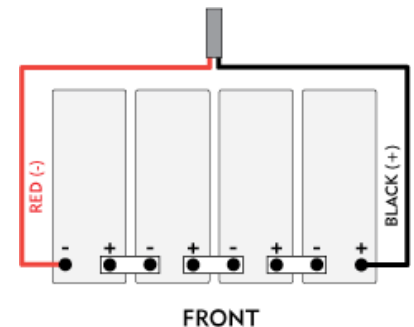

FieldSmart® FiberFlex 2000

Installation Manual



- Step 8:** Before connecting the batteries, pull out one rectifier module.
- Step 9:** Using a digital volt meter, check for correct polarity and test the battery connection between the negative and positive battery leads:
- Place the red voltmeter lead on the red negative (-) battery lead.
 - Place the black voltmeter lead on the black positive (+) battery lead.
 - Verify that the voltmeter reads between -46 and -54 VDC.
 - Measure the voltage difference between the power system and the battery string. The voltage difference should be less than 3V. If the voltage difference is greater than 3V, check for connection integrity, replace bad battery cell as applicable, and retest the voltage. Reconnect the battery power cables to the power supply leads.
- Step 10:** Install the protective covers (manufacturer-supplied) over the battery terminals.
- Step 11:** Connect the string of batteries to the power system by plugging the battery string and the rectifier system output Anderson connectors together.
- Step 12:** Re-install the rectifier module removed in step 8.
- Step 13:** Verify that the cabinet heat exchanger fans are running (if the temperature is high enough).
- Step 14:** At the AC load center, do the following:
- Set the Main breaker to OFF. The heat exchanger fans should continue to run.
 - Set the Main breaker to ON and verify that power restores to the Alpha shelf.
- Step 15:** Slide the battery string into the battery tray.
- Step 16:** Replace the battery compartment door.

To install two strings of 155 Ah batteries (with riser compartment)

Step 1: At the rectifier shelf, open the fuse panel door. Verify that the battery breakers are OFF.

Step 2: Remove the upper and lower battery compartment doors. See Operating Cabinet Doors for instructions.

Note: If you are using the optional battery heater, install the heaters before installing batteries. See Installing a Battery Heater for instructions.

Step 3: In the upper battery compartment, locate the secondary battery supply leads and route down into the riser compartment.

Step 4: In the riser compartment, route the battery supply leads along the sides of the battery tray and then arrange a string of four batteries with the terminals accessible in front.

Note: You will slide the batteries into the battery trays after installing the cables and protective covers.

Step 5: Connect the second-string battery power cables to the string in the riser compartment as follows:

- Attach the black power jumper cable to the positive (+) terminal post at the positive end of the string.
- Attach the red power jumper cable to the negative (-) terminal post at the negative end of the string.

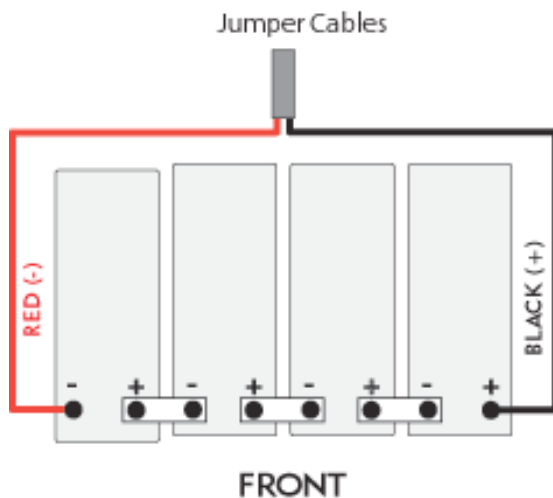

ALERT! Check all connections carefully to verify correct wiring polarities.

c. Tighten the hardware on the terminal posts to the torque specified by the manufacturer.

FieldSmart® FiberFlex 2000

Installation Manual



- Step 6:** Install the three jumper cables between the battery terminal posts using the supplied flat washers, split lock washers, and bolts.
- Step 7:** Before connecting the batteries, pull out one rectifier module.
- Step 8:** Using a digital volt meter, check for correct polarity and test the battery connection between the negative and positive battery leads:
- Place the red voltmeter lead on the red negative (-) battery lead.
 - Place the black voltmeter lead on the black positive (+) battery lead.
 - Verify that the voltmeter reads between -46 and -54 VDC.
 - Measure the voltage difference between the power system and the battery string. The voltage difference should be less than 3V. If the voltage difference is greater than 3V, check for connection integrity, replace bad battery cell as applicable, and retest the voltage. Reconnect the battery power cables to the power supply leads.
- Step 9:** Install the protective covers (manufacturer-supplied) over each battery terminal, and then slide the battery string into the riser compartment battery tray.
- Step 10** In the upper battery compartment, do the following:
- Remove the front retainer bracket from the battery tray.

Note: If you are using the optional battery heater, install the heater before installing batteries. See *Installing a Battery Heater* for instructions.

- Locate the secondary battery supply leads and the (installed) main secondary battery string.



The battery supply leads ship in a bag.

- Connect the Anderson connector on the battery supply leads to the Anderson connector on the main secondary battery string.
- Route the battery supply leads along the sides of the battery tray and then arrange a string of four batteries with the terminals accessible in front.

Note: You will slide the batteries into the battery tray after installing the cables and protective covers.

Step 11: Connect the battery power cables in the upper battery compartment as follows:

- a. Remove the protective caps from the cable ring lugs.
- b. Attach the black cable to the positive (+) terminal post at the positive end of the string.
- c. Attach the red cable to the negative (-) terminal post at the negative end of the string.

ALERT! Check all connections carefully to verify correct wiring polarities.

- d. Install the temperature sensor cable lug onto the string's negative (-) terminal post.
- e. Tighten the hardware on the terminal posts to the torque specified by the manufacturer.

Step 12: Install three jumper cables between the battery terminal posts using the supplied flat washers, split lock washers, and bolts.

Step 13: Check for correct polarity and test the battery connection between the negative and positive battery leads (as described in step 7).

Step 14: Install the protective covers (manufacturer-supplied) over each battery terminal.

Step 15: Reinstall the rectifier module removed in step 6.

Step 16: Verify that the cabinet heat exchanger fans are running (if the temperature is high enough).

Step 17: At the AC load center, do the following:

- a. Set the Main breaker to OFF. The heat exchanger fans should continue to run.
- b. Set the Main breaker to ON and verify that power restores to the rectifier shelf.

Step 18: Slide the battery strings into the upper compartment battery tray.

Step 19: Replace the battery compartment doors.

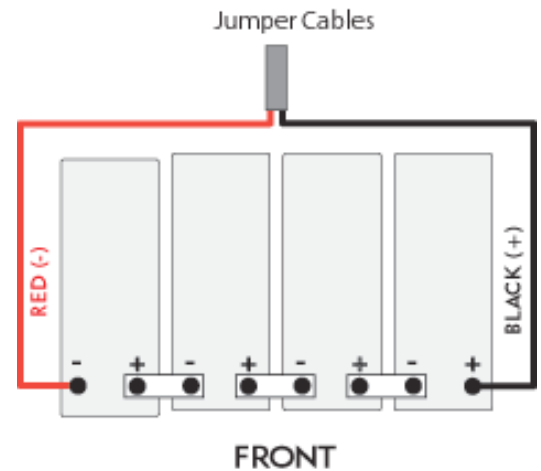

Turning Up and Testing the DC Power System

Turn up and test the cabinet DC bulk power system as described below.

To turn up and test the DC power system

- Step 1:** At the AC load center, verify that the Main breaker is **ON**.
- Step 2:** At the AC load center, switch the 30A Rectifier breaker **ON**.
- Step 3:** Verify that the Eltek power shelf boots up and the rectifier modules are operational.

Note: The Eltek FPS shelf controller is factory programmed with default settings that enable safe power up and operation. You can modify the settings for system voltages, battery configuration, temperature compensation, and so forth, if required. For programming instructions, refer to the Eltek Smartpack S Controllers User Guide.

- Step 4:** At the rectifier shelf, open the fuse panel door and do the following:



- a. To apply power to the first active service unit, install a pair of GMT fuses in fuse positions 1 and 2 (A/B power). Verify that the unit powers up.
- b. If the cabinet is equipped with additional active service units, install an appropriately rated pair of GMT fuses in fuse positions 3 and 4 (for the second service unit) and positions 5 and 6 (for the third service unit, as applicable). Verify that the additional unit(s) power up.
- c. Install a 5A GMT fuse in position 10 and verify that the heat exchanger fans start running (if internal temperature is high enough).
- Step 5:** Using a volt meter, test the DC power supply voltage at the shelf. Verify that the voltage reads between -48 and -54 VDC.
- Step 6:** At the rectifier fuse panel, switch the 30A battery breaker **ON** to charge the batteries.



Testing Batteries

If the batteries are not fully charged, perform this procedure after charging the batteries



WARNING! Electrical hazard. Only a qualified technician should perform these procedures.

To test the batteries

- Step 1:** Using a digital volt meter, test the battery connection between the negative and positive battery leads:
- Place the red volt meter lead on the red negative (-) battery lead.
 - Place the black volt meter lead on the black positive (+) battery lead.
 - Verify that the volt meter reads between -46 and -54 VDC.
 - Measure the voltage difference between the power system and the battery string. The voltage difference should be less than 3V. If the voltage difference is greater than 3V, check for connection integrity, replace bad battery cell as applicable, and retest the voltage.
- Step 2:** Verify that the cabinet heat exchanger fans are running (if the temperature is high enough).
- Step 3:** At the AC load center, set the Main breaker to **OFF**. The heat exchanger fans should continue to run.
- Step 4:** At the AC load center, set the Main breaker to **ON** and verify that power restores to the rectifier shelf.

Chapter 8: Installing Equipment, Options and Adding Capacity

This chapter describes how to install optional equipment and components into the cabinet, including expansion components to increase system capacity. The cabinet allows for modular growth of line capacity and supports field installation of all factory options.

Topics Covered

This chapter covers the following topics:

- Installing a 155 Ah battery compartment riser
- Installing a battery heater
- Installing fiber splitters



Installing a Battery Compartment Riser

Clearfield offers an optional battery compartment riser to support a second 155 Ah battery string. The battery compartment riser ships detached from the cabinet, even when ordered as a factory option. Install the battery compartment riser onto a concrete pad, foundation vault, or pole/wall mount pedestal, and then mount the cabinet assembly (with battery compartment) onto the riser.

To install a 155 Ah battery compartment riser (under the cabinet)

Step 1: Prepare the riser compartment for installation as follows:

- a. Unpack the battery compartment riser from its shipping packaging.
- b. Remove the riser's compartment door. See Operating Cabinet Doors for instructions.
- c. From inside the compartment, remove the hex nuts from the five studs anchoring the splash guard to the top of the compartment.

Step 2: Install the riser onto the concrete pad, foundation vault, or pole/wall-mount fixture. See Installing the Cabinet for detailed instructions.

Step 3: Install the FiberFlex 2000 cabinet onto the riser compartment as follows:

- a. Lift the cabinet onto the riser, keeping the (4) anchor holes in the cabinet base aligned with the counterpart holes in the riser.
- b. Attach the cabinet base to the riser using (4) anchor bolts, (8) flat washers, (4) lock washers, and (4) nuts (one set per each of the four anchor holes).

Step 4: Tighten all hardware to secure the cabinet to the riser.

For battery installation instructions, see Installing Batteries.

Installing a Battery Heater

For colder climates, Clearfield recommends using an optional battery heater to prevent batteries from freezing and to prolong battery life. The battery heater is controlled by a thermostat set for the following operation:

- 4° C – Battery heater turns On.
- 16° C – Battery heater turns Off.

Note: The battery heater sits directly underneath the battery string, so you must install a heater into the battery tray before installing batteries.

To install a battery heater in a battery compartment

Step 1: Unpack the battery heater from the shipping packaging, and then remove the battery compartment door. See Operating Cabinet Doors for instructions.



Step 2: Install the battery heater into the battery tray as follows:

- a. Remove the adhesive backing from the battery warmer

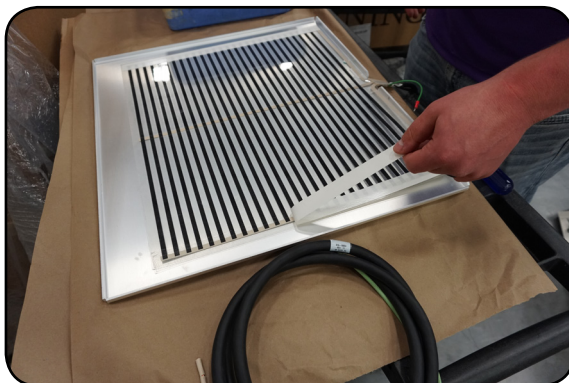

b. Adhere the battery warmer to the inside of the battery warmer mount plate

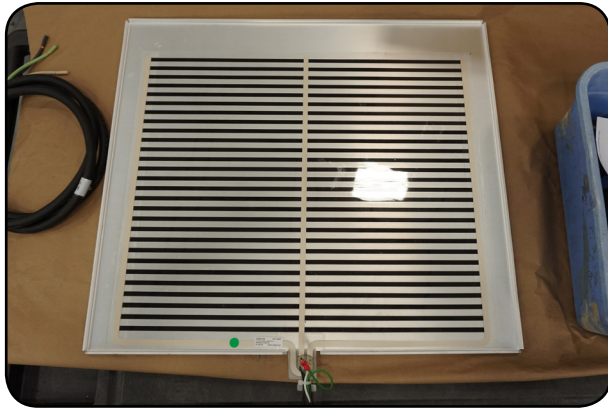

c. Attach the battery warmer ground wire to the battery warmer mount plate ground stud using washer 639-00002 & nut 637-00026.



d. Cut off the 120V plug from the heater strip element power leads. Strip back the cable to expose the white, black, and green cables. Strip back each of these cables 1”.

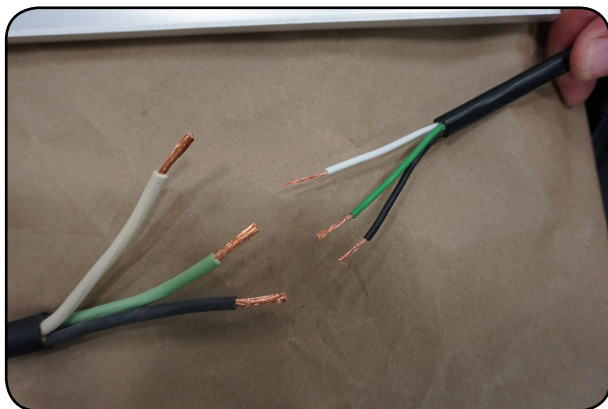

FieldSmart® FiberFlex 2000

Installation Manual



e. Attach the white, black, and green cables of the battery warmer assembly to the white, black, and green cables of the provided AC power cords using 3x wire nuts.

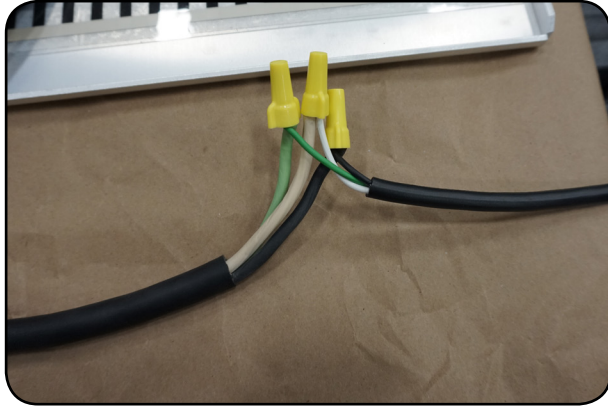

f. Install the battery warmer assembly in the battery base on top of the plastic pad with the assembly towards the left side of the cabinet. The battery warmer will rest in place and it does not need to be fastened down.



Step 3: Route the temperature sensor/thermometer through one of the cutouts in the side channel. The thermostat will later be rested on top of the batteries after they are installed.



Step 4: Install a 15A breaker into the AC Load Center (ACLC) as follows:

- a. Remove the ACLC face plate. Remove the knockout from the ACLC face plate. Location 8 for the 1st battery warmer breaker, and Location 10 for the 2nd battery warmer breaker.

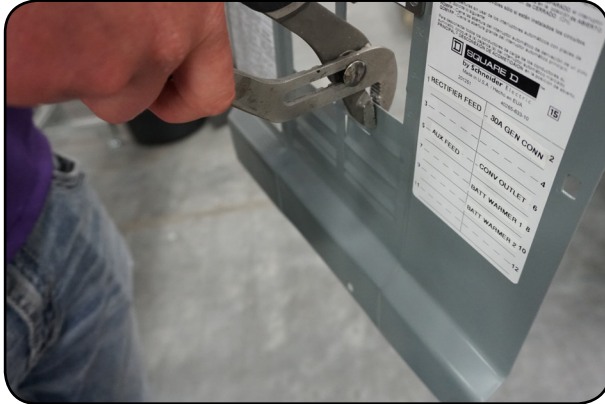

- b. Install the 15A breaker into the ACLC.

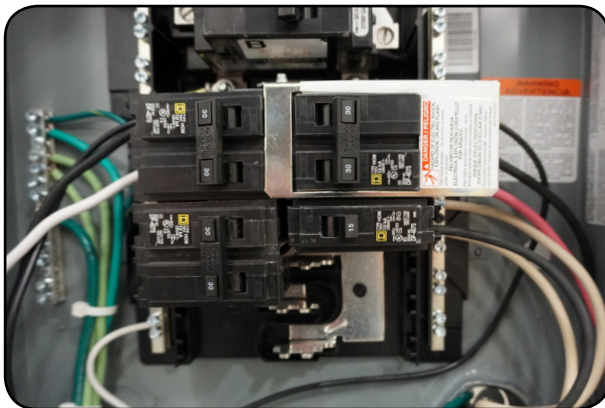

Step 5: Install the AC power cords into the AC Load Center (ACLC) as follows:

- a. Remove a grommet through an unused feedthrough in the cabinet base. Run the AC power cords up into the back of the cabinet through this open feed through.



FieldSmart® FiberFlex 2000

Installation Manual



b. Install the grommet onto the AC power cords and push it back along the cable out of the way.

c. Run the AC power cords through the cabinet and into the ACLC. The thick jacket of the cable should extend into the ACLC by ~1-2”.

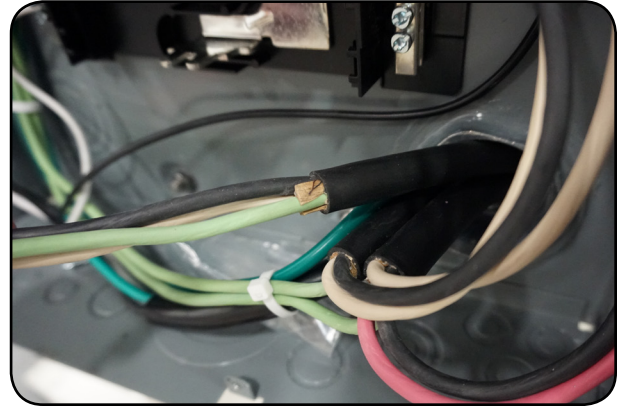

d. Push the grommet down the cable to the correct position, and install the grommet into the feed through hole to seal it off. Excess slack in the cable should be stored in the battery base.



e. In the ACLC, attach the ground and neutral wires from the cable to the ground and neutral bars in the ACLC.



f. Attach the black wire to the 15A breaker installed in step 4.

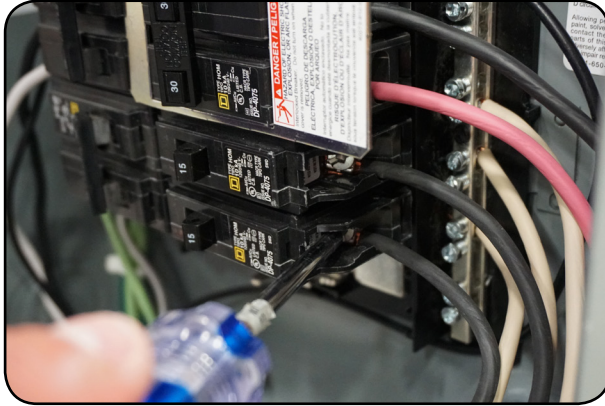

g. Reinstall the ACLC faceplate



FieldSmart® FiberFlex 2000

Installation Manual



Installing Fiber Splitters

The FieldSmart FiberFlex 2000 will arrive with patch-only panels and slack trays pre-installed. Install splitters and route the splitter legs as shown.

Pictured is the interior of the FiberFlex 2000 loaded with two 288 panels and both slack trays installed.

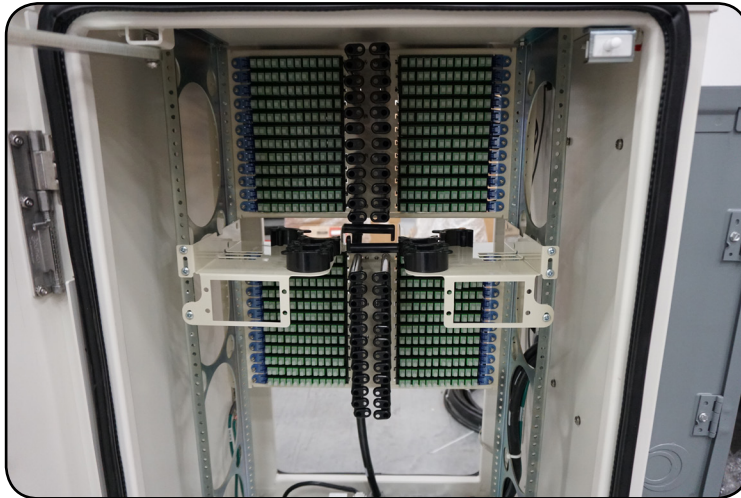

Step 1: Install the WaveSmart HD Splitters into the slack trays.

a. Install the splitter staging plate into the staging area located on the front face of the slack tray. Insert the push/pull plungers into the holes in the staging area and press on the plungers until they click, locking the staging plate into place.

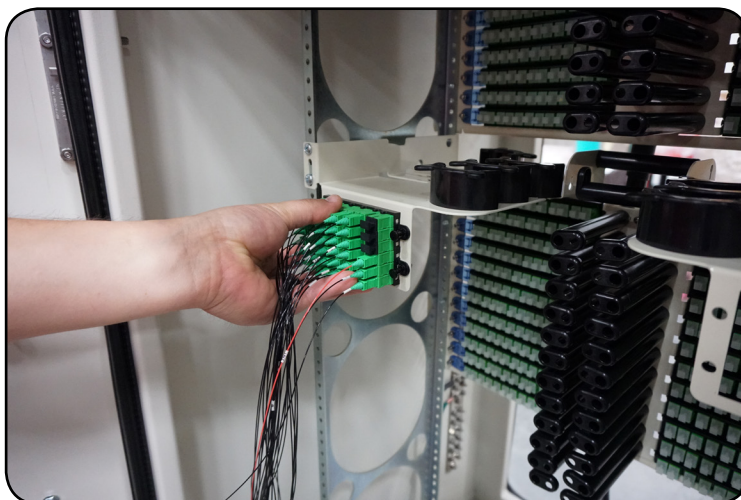

b. Install the splitter body into the slots on the splitter tray, with the splitter legs facing towards the back of the cabinet. Use velcro to hold the splitter body(s) in place.

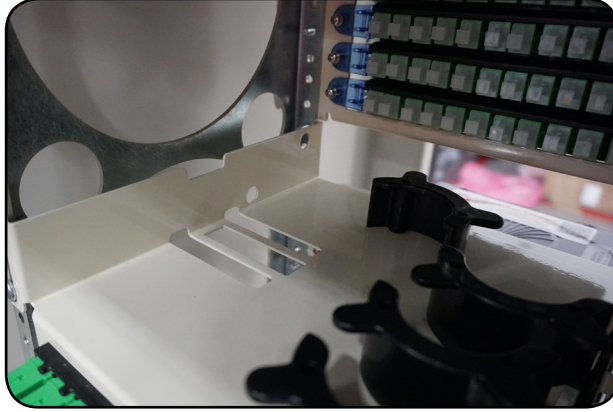

c. Using velcro or curly locks installed into the interior of the frame, support the slack of the splitter legs as shown.

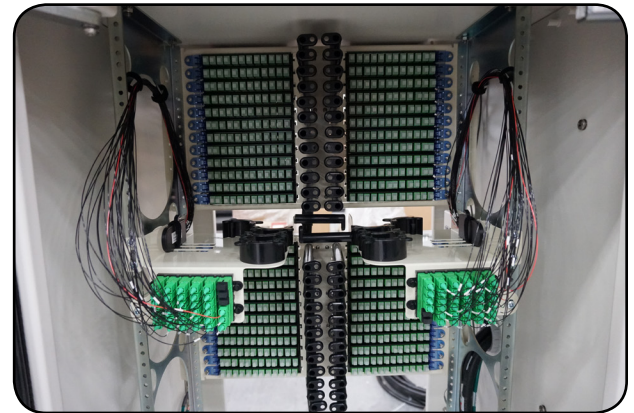
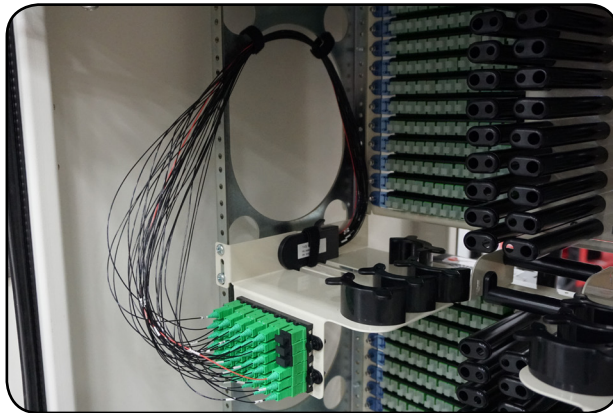

Step 2: Route the splitter legs as needed. Splitters installed into the left slack tray are intended to be connected into ports in the panel above, while splitters on the right slack tray are for the panel below.



FieldSmart® FiberFlex 2000

Installation Manual



- a. Depending on the distance to the desired port that the splitter leg will be connected to, use the half moons on the top face of the slack tray to take up slack as needed.
- b. If connecting to a port on the top panel, route under/over the horizontal radius finger attached to the side of the slack tray before traveling upwards/downwards between the two vertical rows of radius fingers.
- c. Route the splitter leg through the gap between two of the radius fingers corresponding to the row of adapters in which the connect will be installed. Make the connection.



Note: If the distance to the adapter is too great, it may be necessary to skip routing the splitter leg under/over one of the horizontal slack tray radius fingers and instead transition to routing between the two vertical rows of radius fingers immediately after rounding the first half moon.

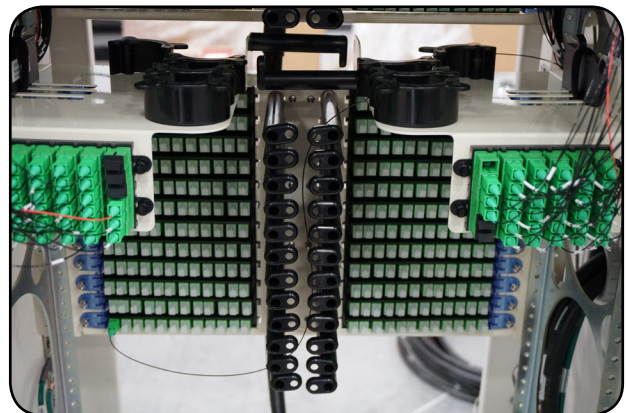
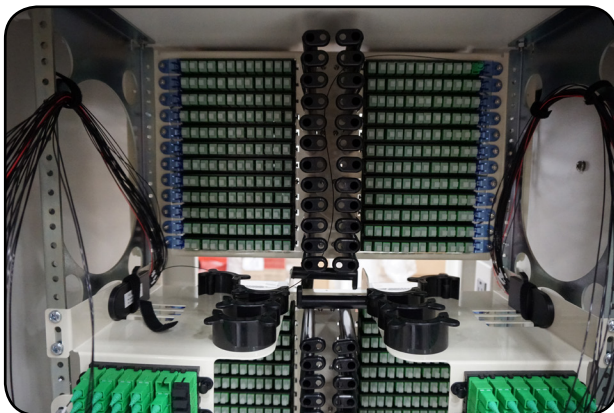

FiberFlex 2000 Fiber Transport Module

Clearfield offers a Fiber Transport Module solution. If ordered, the Fiber Transport Module can be installed in-between the rack and the wall on the front left side of the cabinet where space is available, using the slotted holes present on the transport module.

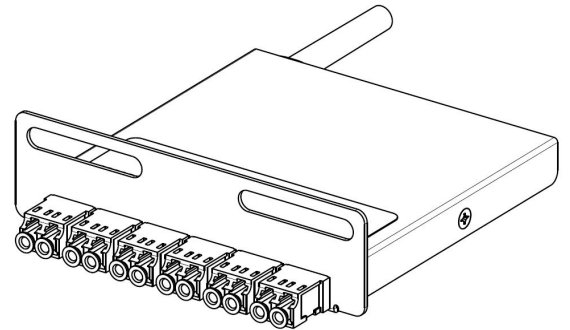
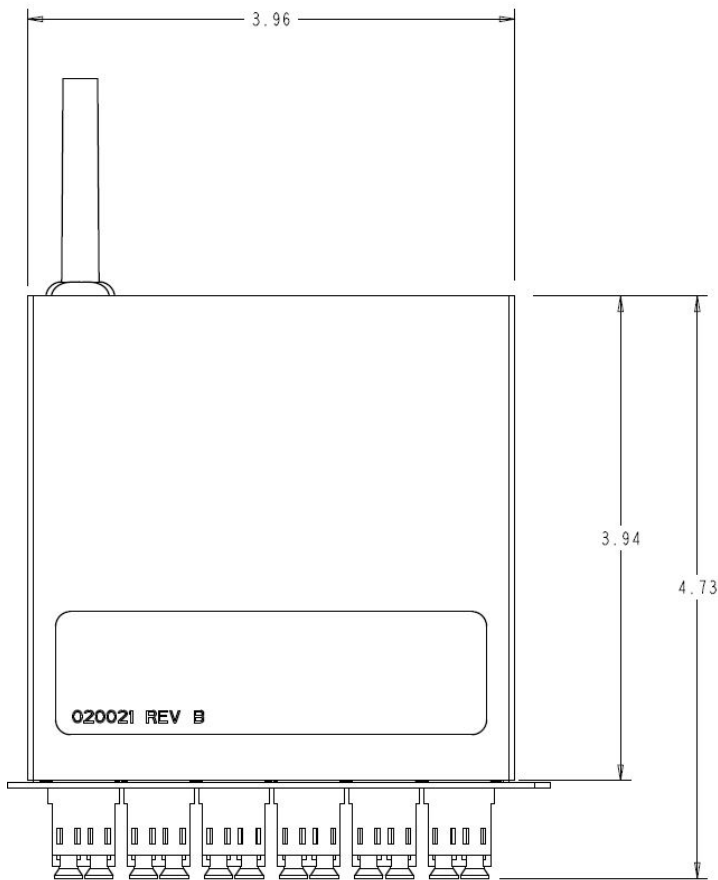

Chapter 9: Cabinet Maintenance

This chapter describes how to perform cabinet maintenance, including routine maintenance and corrective maintenance to replace worn or failed parts and equipment.

Topics Covered

This chapter covers the following topics:

- Routine cabinet maintenance
- Replacing parts and equipment



Routine Maintenance

This section describes how to perform routine maintenance on the cabinet.

Checking Cabinet Surfaces

Clean and inspect the cabinet for contaminants, damage, and wear once a year. Items to check include the following:

Inspect interior surfaces

Items to check inside the cabinet include the following:

- Inspect the interior of the cabinet for signs of visible damage to the metal or paint.
- Note any damage to the metal work. If the damaged area interferes with operation of the cabinet or electronics, contact Clearfield support for assistance with a resolution.
- Repair damage to the paint using touch-up paint available from Clearfield after cleaning the surface and removing rust.
- Inspect all gaskets around the doors and the roof to ensure a tight secure fit.

Inspect exterior surfaces

Items to check outside the cabinet include the following:

- Inspect the exterior of the cabinet for signs of damage to the metal work or paint.
- Repair damage to the paint using approved type touch-up paint after cleaning the surface and removing rust.
- Note damage to the metal work. If the damaged area interferes with operation of the cabinet or electronics, contact Clearfield support for assistance with a resolution.
- Clean all surfaces so that they are free of dirt, dust, and foreign material.
- Remove all material from air intake screens and louvers (i.e. spider webs, leaves, etc.).
- Clean the air vents on the heat exchangers and the battery compartment with a dry, soft brush to ensure optimal airflow.

Checking Electrical Components

Check all electrical components in the cabinet for wear at least once a year.

In cabinets configured for local power, inspections include:

- Check the circuit breakers on the AC load center. Verify that all breakers are in the ON position.
- Check the AC surge arrester on the AC load center. Verify that the operational indicators are lit.
- Check the GFCI convenience outlet. Test the outlet per local code.
- Check the controller module on the rectifier shelf. Verify that the controller operational indicator is lit.
- Check the rectifier modules in the rectifier shelf. Verify that the operational indicators are lit on each module.
- Check the circuit breaker and fuses on the rectifier shelf. Verify that the breaker is in the ON position and that no fuses are blown.
- Check the heat exchanger. Verify that the air intake locations are unobstructed and that the fans are running.

If any of the inspected items requires replacement due to failure or damage, replace the item as described in Replacing Parts and Equipment.



Checking Cable Connections

Check external cable connections at least once a year. External cables are any cable that enters the cabinet from the outside plant.

- Visually inspect all cables for signs of physical damage. If damage is present, cables should be repaired or replaced per local practice.
- Check all outside plant copper connections for complete and secure connection.
- Ensure that all cable management accessories provide a clean appearance. Replace any fastening devices (i.e. cable ties) so that they include all cables being secured.
- Check all fiber optic connectors to ensure that they are securely fastened.
- Check all connections on the cabinet ground bar for a tight and secure fit.
- Check all protector modules to ensure that all devices are securely seated.
- Check all conduits to ensure that any material used to seal between the cable and the conduit is still present and providing a complete seal.

Checking the Heat Exchanger



CAUTION! Always disconnect power to the heat exchanger prior to servicing.

Check the heat exchanger for proper functioning at least once a year.

- Verify that no fan failure alarms are present.
- Verify fan operation, including visual inspection the following:
 - Verify that all fans are spinning with no obstructions or odd noises.
 - Verify that the heat exchanger is secured to the cabinet and all gasket material is intact and adhered to the cabinet door surface.

Check the heat exchanger for required cleaning based on the environmental conditions (typically once a year).

- Verify that no debris is blocking the inlet and outlet vent screens. Place a piece of paper against the inlet vent and verify that the paper is drawn in; place a piece of paper against the outlet vent and verify that the paper is blown out. Use a whisk broom or other device to clear the vents if debris is present.
- Use a soft bristle brush to remove dust or debris from the fans and heat exchanger core as needed.

Note: *If available, you may use low pressure compressed air (up to 30 PSI) in addition to, or in place of, a soft bristle brush. Compressed air should only be used with cabinet doors closed and only on the external sides of the heat exchanger core. Be sure to use appropriate eye protection.*

- For more extensive cleaning, you can remove the exterior heat exchanger cover (by removing the two screws at base of the cover) and the individual cover plates behind the main cover.

Battery Maintenance

Battery maintenance applies to locally powered cabinets only. Perform routine inspection and maintenance of batteries to improve battery life. Follow the manufacturer's maintenance recommendations. Additional general maintenance guidelines are provided below.

Battery maintenance does not impact cabinet service, provided that an AC power failure does not occur during the maintenance process. Clearfield recommends connecting an external generator to the cabinet while performing battery maintenance to ensure service continuity in the event of an AC outage.



WARNING! Electrical hazard. Batteries contain a stored charge. Only a qualified technician should perform this procedure.



CAUTION! Electrical, chemical, fire, and heat hazard. Handle batteries with care to avoid personal injury or damage to the equipment.



ALERT! To ensure service continuity in the event of an AC outage, connect an external generator to the cabinet while performing battery maintenance.

To perform battery maintenance

- Step 1:** At the rectifier shelf, open the fuse panel door. Switch the battery breaker to OFF.
- Step 2:** Remove the battery compartment door. See Operating Cabinet Doors for instructions.
- Step 3:** To remove the batteries from the battery compartment:
- a. Disconnect the battery power cables from the power supply terminals.
 - b. Slide the batteries out of the battery compartment.
 - c. Remove the protective covers from the battery terminals.
 - d. Remove the red and black battery power cables from the terminals at each end of the string.
 - e. Remove the jumper straps from between the terminals of the batteries in the string.

FieldSmart® FiberFlex 2000

Installation Manual



Step 4: Visually inspect each battery for defects such as:

- Fractured housing or other physical damage
- Leakage
- Bulging

Note: Replace any battery that displays a defect. See *Replacing Batteries* for instructions.

Step 5: Perform the following maintenance tasks:

- a. Load test each battery to verify that ample current is available to maintain the system.
- b. Ensure that each battery provides 13.5 VDC (plus or minus .2 VDC).
- c. Clean each battery to remove dust, dirt, or corrosion from the battery surface.

Note: Only use water for cleaning the battery surface. Do not use any chemicals.

- d. Clean the battery terminals and apply No-Ox anti-corrosion grease to each.
- e. Record the inspection and maintenance details in the cabinet records per local practice.

Step 6: Inspect the battery compartment for any signs of damage. Clean the compartment and fix any damage to painted areas by removing all rust and dirt from the affected area, and then applying touch-up paint to the area to prevent future corrosion.

Step 7: Re-install the batteries into the battery compartment. See *Installing Batteries* for instructions.

Replacing Parts and Equipment

This section describes how to replace worn or failed parts and equipment in the cabinet.

Removing a Cabinet Door

You can remove the cabinet doors for convenience during cabinet installation or maintenance activities, or to replace a door.

Replacing a cabinet door may become necessary if a door becomes damaged.

You can replace cabinet doors in the field without impacting service.



CAUTION! Handle detached cabinet doors with care to avoid personal injury or damage to the door.

To remove a cabinet door

- Step 1:** For a door (equipped with a heat exchanger), disconnect the heat exchanger cable.
- Step 2:** Disconnect the ground strap from the door by removing the hex nut. Save the nut to re-attach the strap to the new door.
- Step 3:** Disconnect the wind brace bracket from the door:
- Remove the three nuts securing the wind brace bracket to the door. Save the nuts to re-attach the bracket to the new door.
 - Detach the wind brace bracket from the three studs on the door.



FieldSmart® FiberFlex 2000

Installation Manual



Step 4: On the door hinges, disengage the hinge pin lever from its cradle:

- a. **Top hinge:** Lift the pin lever up and rotate it away from the cradle.
- b. **Bottom hinge:** Press the pin lever down and rotate it away from the cradle.

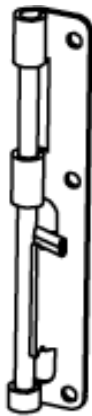

Pin lever engaged

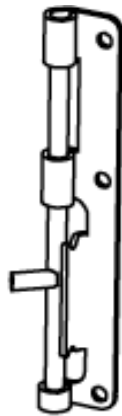

Pin lever disengaged

Step 5: Release the hinge pins from the hinge pin channels as follows:

- a. **Top hinge:** Press down on the pin lever until the pin slides free from the channel.
- b. **Bottom hinge:** Lift up on the pin lever until the pin slides free from the channel.

Installing a Cabinet Door

You can quickly install a cabinet door in the field without impacting service.



CAUTION! Handle cabinet doors with care to avoid personal injury or damage to the door.

To install a cabinet door

Step 1: Unpack the new door from its shipping packaging.

Step 2: On the new door hinges, disengage the hinge pin lever from its cradle:

- a. **Top hinge:** Lift the pin lever up and rotate it away from the cradle.



FieldSmart[®] FiberFlex 2000 Installation Manual

Step 2: **b. Bottom hinge:** Press the pin lever down and rotate it away from the cradle.



Pin lever engaged

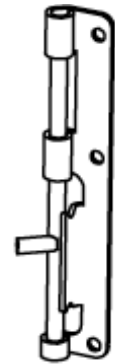

Pin lever disengaged

Step 3: Release the hinge pins from the hinge pin channels:

a. Top hinge: Press down on the pin lever until the pin slides free from the channel.

b. Bottom hinge: Lift up on the pin lever until the pin slides free from the channel.

Step 4: Insert the new door into the door frame. Align the door hinge knuckles with the counterpart hinge knuckles on the door frame.

Step 5: Engage the hinge pins to secure the door in place as follows:

a. Top hinge: Lift up on the pin lever until the pin slides completely into the pin channel.

b. Bottom hinge: Press down on the pin lever until the pin slides completely into the pin channel.

c. Rotate the pin levers into the cradles to secure the hinges.

Step 6: Attach the wind brace bracket to the inside of the door using the three nuts removed from the previous door.

Step 7: Attach the ground strap to the door using the hex nut removed from the previous door.

Step 8: For a heat exchanger door, connect the heat exchanger power (and alarm) cable to the cabinet wiring:

a. Locate the heat exchanger cable on the inside of the door.

b. Route and connect the heat exchanger cable to the cabinet extension cable.



Replacing the Cabinet Roof

If the cabinet roof becomes damaged, you can replace the roof in the field as described below.

To replace the cabinet roof

- Step 1:** Open the cabinet side door.
- Step 2:** Remove the (3) Keys nuts securing the protection mounting frame to the side of the cabinet.
- Step 3:** Push the top of the mounting frame toward the front of the cabinet, as far as it will go.
- Step 4:** Using an offset screwdriver, remove the screw in the interior roof above the mounting frame.



- Step 5:** Remove the (3) remaining screws in each corner of the interior roof, and set aside.
- Step 6:** Lift and remove the damaged roof from the cabinet.
- Step 7:** Place the replacement roof on the cabinet.
- Step 8:** Secure the roof in place using the screws removed in step 5.

Replacing AC Breakers

On cabinets configured for local power, if a circuit breaker in the AC load center fails or becomes damaged, you can replace the breaker in the field as described below. If the cabinet is equipped with charged batteries, this procedure does not affect service.



DANGER! High voltage may be present. Only a qualified electrician should perform this task. Follow NEC and local codes when handling power systems. Do not restore AC power until the task is complete.

To replace an AC circuit breaker

Step 1: At the local power transfer switch, disconnect AC power to the cabinet.

Note: *If the cabinet is equipped with charged batteries, this action does not affect service. The equipment automatically switches to battery reserve power.*

Step 2: At the AC load center, switch the Main circuit breaker to OFF.

Step 3: Remove the cover panel from the AC load center.

Step 4: Remove any wires from the defective circuit breaker.

Step 5: Remove the defective breaker from the load center and replace it with a new breaker of the same type and rating.

Step 6: Reconnect all wiring to the new circuit breaker.

Step 7: Replace the AC load center cover panel.

Step 8: At the AC load center, switch all breakers to ON.

Step 9: At the local power transfer switch, restore AC power to the cabinet.

Replacing Rectifier Modules

On cabinets configured for local power, if a rectifier module experiences a failure, you can replace the module in the field. Rectifier modules are hot-swappable and can be replaced without disconnecting power to the Eltek FPS shelf.

To replace an Eltek rectifier module

Step 1: Remove an installed rectifier module as follows:

- a. Turn the flathead screw in the lower right corner clockwise 1/2 turn to release the spring.
- b. Pull forward on the handle to unseat the module.
- c. Grasp the module and slide it out of its slot. Set the module aside.

Step 2: Install a new rectifier module as follows:

- a. Insert the new rectifier module into the vacated slot.
- b. Push firmly on the module to seat it in the slot.

Step 3: Repeat Steps 1 and 2 to replace an additional rectifier module.

As each rectifier module is installed, the shelf controller automatically identifies the new module and configures the system. If a shelf controller fails, the system remains at the last known settings until a new controller is installed. The controller is hot-swappable, and so can be replaced while the system is operating without any interruption.

To replace an Eltek Smartpack S controller module

Step 1: Remove the installed controller module as follows:

- a. Turn the flathead screw in the lower right corner clockwise 1/2 turn to release the spring.
- b. Pull forward on the handle to allow access to the (5) alarm interface connectors.
- c. Disconnect the alarm wires and temperature probe cable from each alarm interface connector:
 - Push orange tab in, and then remove the alarm wire from the connector.
 - Release the orange tab.
- d. Grasp the module and slide it out of its slot. Set the module aside.



FieldSmart[®] FiberFlex 2000

Installation Manual

Step 2: Install a new controller module as follows:

- a. Insert the new controller module partially into the vacated slot, allowing access to the (5) alarm interface connectors.
- b. Connect the alarm wires to the alarm input and output positions (see table below for guidance).
 - Push the orange tab in, and then insert the alarm wire in the connector.
 - Holding the wire in place, release the orange tab.
- c. Connect the temperature probe cable as follows:
 - Connect the red alarm wire to P1 PIN 6 (+).
 - Connect the black alarm wire to P1 PIN 6 (-).
- d. Push firmly on the module to seat it in the slot.

When the controller operational indicator is lit, it has completed its initialization and is ready to operate on the default settings.

Note: For instructions on programming the controller module, see the Eltek Smartpack A Controllers User Guide.

The Eltek Smartpack S controller module is equipped with four alarm interface connectors. The alarm connector cabling scheme follows.

P(X) PIN #	DESCRIPTION	WIRE COLOR
P3 PIN 3	A-NC (Power Major)	White
P3 PIN 2	A-C	Black
P3 PIN 6	B-NC (Power Minor)	Red
P3 PIN 5	B-C	Green
P4 PIN 3	C-NC (AC Fail)	Orange
P4 PIN 2	C-C	Blue
P4 PIN 6	D-NC (Battery on Discharge)	White/Black
P4 PIN 5	D-C	Red/Black
P1 PIN 3	ALARM IN	Green/Black
P1 PIN 4	ALARM IN (RTN)	Orange/Black

Eltek FPS Rectifier Alarm Matrix

The Eltek FPS rectifier shelf detects multiple alarm conditions on the cabinet power system, but reports an umbrella Power Major (Power MJ) alarm to the E7-2, B6-001, and E5-100. The following table lists potential alarm conditions on the Eltek FPS shelf that report to the service units as Power MJ.

Alarm Condition	Native Severity	
	Minor	Major
AC Fail (Mains Fail)		X
High Voltage Warning		X
High Voltage Shut Down (HVSD)		X
Battery on Discharge		X
Low Voltage Warning	X	
Distribution		X
Rectifier Current Share	X	
Single Rectifier Fail		X
Multiple Rectifier Fail		X
Module Communication	X	
Low Voltage Battery Disconnect (LVBD)		X



Eltek FPS Rectifier Controller Settings

The default settings for the Eltek FPS Rectifier shelf controller follow.

Parameter	Enabled	Disabled	Default Setting
System Voltages			
System Nominal Voltage			-48.00V
System Number of Battery Cells			24 Cells
System Reference Voltage (Total)			-54.00V
System Reference Voltage (Cell)			-2.25V/Cell
System Boost Voltage		x	-54.00V
Rectifier Standby Voltage			-44.40V
Battery Disconnect Voltage		x	-42.00V
Battery Reconnect Voltage		x	-50.00V
Rectifier Over Voltage Shutdown			-58.80V
Rectifier Configuration			
Redundant Rectifiers Percentage (%)			0
Suppress Rectifier Alarms (when mains = 0 Volts)	x		
Rectifier Silence Alarm		x	
Rectifiers Walk-in Time			Short Time
Rectifiers Current Limitation (A)		x	100 Amps
Rectifiers Emergency Voltage			-53.52 Vdc
Rectifiers Generator Dependency Delay		x	
Rectifiers Startup Delay			0 Minutes
Rectifiers Efficiency Management		x	
Rectifiers HE Priority		x	
Rectifier Alarms Configuration			
Rectifier Communication Minor	x		1 Rectifier
Rectifier Communication Major	x		2 Rectifiers
Rectifier Error Minor	x		1 Rectifier
Rectifier Error Major	x		2 Rectifiers
Rectifier Current Share Alarm (%)	x		5%–10%

FieldSmart® FiberFlex 2000

Installation Manual



Battery Configuration			
Number of Battery Banks			1
Number of Battery Strings			1
Number of Battery Cells			24
Battery Table			Etek-Std
Temperature Compensation	x		
Thermal Minimum Compensation			-2.1V/Cell
Thermal Maximum Compensation			-2.35V/Cell
Thermal Comp Reference Voltage			-2.25V/Cell
Thermal Comp Reference Temperature			20°C
Thermal Comp Temp Slope			3mV/C/Cell
Battery Charge Current Limit	x		10 Amps
Battery Test & Duration		x	720 Minutes
Battery Test End Voltage		x	1.90 V/Cell
Battery Test Maximum Discharge (Ah)		x	100 Amps
Battery Test Guard Time (Hours)		x	12 Hours
Battery Interval Test & Duration		x	180 Days
Battery Interval Test End Voltage			1.90V/Cell
Battery Automatic Test		x	1.90V/Cell
Battery Boost & Voltage		x	-54.00V
Battery Boost Current Threshold (A)		x	1.0 Amp
Battery Interval Boost		x	120 Minutes
Battery Automatic Boost		x	120 Minutes
Battery Equalize & Voltage		x	-54.50V
Battery Equalize & Duration		x	120 Minutes
Battery Equalize Current Threshold (A)		x	1.0 Amps
Battery Interval Equalize & Duration		x	120 Minutes
Battery Symmetry Monitoring		x	24V
Battery Symmetry Mode		x	Continuous
Battery Symmetry Discharge Delay		x	0 Minutes
Battery Shunt Monitoring & Shunt Type	x		50mV/100A



FieldSmart® FiberFlex 2000

Installation Manual

Battery Alarms Configuration			
Battery Voltage High Major	x		57.00 VDC
Battery Voltage High Minor	x		56.00 VDC
Battery Voltage Low Minor	x		48.00 VDC
Battery Voltage Low Major	x		46.50 VDC
Battery Temp High Threshold Major	x		60°C
Battery Temp High Threshold Minor	x		55°C
Battery Temp Low Threshold Minor	x		-35°C
Battery Temp Low Threshold Major	x		-40°C
Battery Current Alarm	x		
AC Mains Alarms Configuration ¹			
Number of AC Mains Phases			1
AC Mains High Major	x		280 VAC
AC Mains High Minor	x		260 VAC
AC Mains Low Minor	x		100 VAC
AC Mains Low Major	x		80 VAC
LVBD Configuration (applies to LVD versions)			
LVBD	x		N/A
LVBD Open Voltage			-42.00V
LVBD Reconnect Voltage			-50.00V
LVBD Reconnect Delay Time			0
Battery Fuse Alarm (applies to both LVD and non-LVD versions)	x		N-Closed
LVLD Configuration			
LVLD		x	N/A
LVLD Open Voltage			N/A
LVLD Reconnect Voltage			N/A
LVLD Reconnect Delay Time			N/A
Load Fuse Alarm	x		Diode Matrix

¹ AC Mains = AC Fail

Replacing Batteries

If a battery or string of batteries fails, becomes damaged, or wears out its life, you can replace the battery or string as described below. Replacing batteries does not impact cabinet service, provided that an AC power failure does not occur during the replacement process. Clearfield recommends connecting an external generator to the cabinet while performing battery maintenance to ensure service continuity in the event of an AC outage.



WARNING! Electrical hazard. Batteries contain a stored charge. Only a qualified technician should perform this procedure.



CAUTION! Electrical, chemical, fire, and heat hazard. Handle batteries with care to avoid personal injury or damage to the equipment.



ALERT! To ensure service continuity in the event of an AC outage, connect an external generator to the cabinet while performing battery maintenance.

To replace batteries

- Step 1:** At the rectifier shelf, switch the battery breaker to OFF.
- Step 2:** Remove the battery compartment door. See Operating Cabinet Doors for instructions.
- Step 3:** To remove an old 155 Ah battery string:
- Disconnect the battery power cables from the power supply terminals.
 - Slide the batteries out of the battery compartment.
 - Remove the protective covers from the battery terminals.
 - Remove the red and black battery power cables from the terminals at each end of the string.
 - Remove the jumper straps from between the terminals of the batteries in the string.
- Step 4:** Install the new batteries into the battery tray. See Installing Batteries for instructions.
- Step 5:** Re-install the seismic protection bracket, if present.
- Step 6:** Replace the battery compartment door and switch the battery breaker to ON.



Replacing a Battery Heater

If the optional battery heater fails or becomes damaged, you can replace it in the field. Replacing a battery heater requires removing the batteries from the battery compartment.

To replace a battery heater

- Step 1:** At the rectifier shelf, switch the battery breaker to OFF.
- Step 2:** At the AC load center, switch the Battery Heater breaker to OFF.
- Step 3:** Remove the battery compartment door. See Operating Cabinet Doors for instructions.
- Step 4:** If present, remove the batteries from the battery compartment. See Replacing Batteries for battery removal instructions.
- Step 5:** Remove the battery heater from the battery tray:
- a. Disconnect the heater power cord from the supply lead, located on the left compartment wall.
 - b. Disconnect the thermostat from the side of the battery tray.
 - c. Lift the battery heater out of the battery tray.
- Step 6:** Install the new battery heater into the battery tray. See Installing a Battery Heater for instructions.
- Step 7:** Re-install and reconnect the batteries. See Installing Batteries for instructions.
- Step 8:** At the AC load center, switch the Battery Heater breaker to ON.
- Step 9:** Replace the battery compartment door and switch the battery breaker to ON.

Appendix A: Reference Information

This appendix provides general reference information about the FiberFlex 2000 cabinet.

Topics Covered

This chapter covers the following topics:

- Cabinet specifications
- Optional Alpha Cordex HP rectifier alarms and controller settings
- Supported batteries
- Wiring diagrams



FieldSmart® FiberFlex 2000

Installation Manual

Specifications

Specifications for the Clearfield FiberFlex 2000 cabinet follow:

FieldSmart FiberFlex 2000	
Dimensions	Base cabinet with Battery Compartment: 54"H x 24"W x 35"D Base Cabinet with 2nd Battery Compartment Option: 66"H x 24"W x 35"D
Weight	Cabinet with Battery Compartment: 250 lbs. Equipped with one 155 Ah battery string: 650 lbs.
Mounting Options	Pre-Cast or Pour-in-Place Pad Template, FUTURE: Wall/H-Frame Mount and Vault/Riser (3rd Party Supplied)
AC Power Center Options	AC Power feed: 240 VAC single phase, 50/60HZ, 125 Amp service with UL listed service panel. High power AC surge protection (Joslyn)
AC/DC Rectifier Option	Eltek Flatpack S (FPS) 1RU -48vdc Rectifier System No-LVD, Two 20 Amp rectifier modules, autosenses and adjusts for low and high AC input Smartpack S Controller. Nominal Input Voltage Range: (185 - 270 VAC): Max. total power output 1000 Watts; Max. total current 40 Amps (2 modules) or 20 Amps (2 modules N+1)
Battery Capacity	Designed to accommodate (2) strings of Northstar NSB 155FT RED batteries. One string support in the standard battery compartment. Dual battery string support using expanded backup option with second battery compartment orders. (Increases capacity to 310Ah total backup). For all other battery types required, compartment space is as follows: 11.2"H x 5"W x 22"D
Cooling/Environmental	1000-Watt cooling capacity with Dantherm door mount heat exchanger Ambient operating temperature range: -40°C to +46°C (-40°F to +115°F)
Wired Fiber Capacity	Up to 576 SC connector fiber terminations Up to eighteen integrated PON splitters
Fiber Management Options	Fiber management: Up to 576 position fiber distribution in 144 or 288-port increments, SC/APC connector, loose tube or ribbon. Up to eighteen integrated splitters in various ratios available
Available Rack Units	20RU in a standard 19" rack 6RU with full 576 fiber distribution SC ports and rectifier option
Safety and Compliance	Designed to Telcordia, GR-487, Generic Requirements for Electronic Equipment Cabinets, UL E-6294

FieldSmart® FiberFlex 2000

Installation Manual



Supported Batteries

The FiberFlex 2000 supports the following battery string with the 60 Ah battery base.

Manufacturer	Model	Capacity (Ah) per String	Max # of Strings
Enersys	SBS 12V155FS	155 Ah	1*
Northstar	NSB 155 FT RED	155 Ah	1*

* 2 strings are supported when the cabinet is equipped with an optional battery compartment riser.

Wiring Diagrams

For wiring diagrams of the FiberFlex 2000 cabinet power, ground, and alarm systems, check seeclearfield.com.



Standard Warranty

Clearfield warrants to the original purchaser of the Product sold hereunder is free from defects in material and workmanship under normal use and service, subject to exceptions stated herein. Product purchased is warranted as follows: Clearfield designed and branded Products are warranted for three (3) years; Products manufactured by Clearfield to customer prints and/or specifications are warranted for one (1) year; and any Product Clearfield acquires from or through a third-party manufacturer or distributor and resells to Customer as the original customer will carry the manufacturer's pass-through warranty, if any. In all cases, the warranty period commences on the date of shipment to the original purchaser.

Warranty Claim Procedure

If any Product purchased from Clearfield is found defective under the above warranty, the following basic procedure must be followed:

1. Customer must contact Clearfield and obtain a Return Materials Authorization
2. Following authorization, the Customer ships the product-freight collect-to Clearfield's manufacturing facility
3. Clearfield shall repair or replace the defective Product at its sole option and discretion, and return the repaired or replacement Product to Customer's site, freight prepaid

Note: If the Product is not found to be defective by Clearfield, the product will be returned to the Customer and the customer billed for freight in both directions.

View our warranty policy here: <https://www.seeclearfield.com/warranty.html>

Limitations of Warranty

Correction of defects by repair or replacement, at the option of Clearfield Inc, shall constitute the exclusive sole remedy for a breach of this limited warranty. Clearfield shall not be liable under any circumstances for any special, consequential, incidental, punitive, or exemplary damages arising out of or in any way connected with the product or with agreement to sell product to buyer, including, but not limited to damages for lost profits, loss of use, or for any damages or sums paid by buyer to third parties. The foregoing limitation of liability shall apply whether the claim is based upon principles of contract, warranty, negligence or other tort, breach of statutory duty, principles of indemnity or contribution, the failure of any limited or exclusive remedy to achieve its essential purpose, or otherwise.

Clearfield will not be responsible for any labor or materials costs associated with installation or incorporation of Clearfield products at customer sites, including any costs of alteration, replacement or defective product, or any field repairs.

Other Limitations

Clearfield assumes no warranty liability regarding defects caused by:

1. Customer's modification of Product, excepting installation activities described in Clearfield documentation
2. Customer re-packaging of Product for shipment to third parties or destinations other than those originally shipped to by Clearfield, or any defects suffered during shipping where the Product has been re-packaged
3. Customer's installation or maintenance, excepting activities described in and performed in accordance with Clearfield documentation
4. Customer's improper or negligent use or application of Product
5. Other causes external to the Product, including but not limited to accidents, catastrophe, acts of God, government action, war, riot, strikes, civil commotion, sovereign conduct, or the acts or conduct of any person or persons not party to or associated with Clearfield
6. Environmental factors and weathering resulting in aging and damage not necessary or applicable to the function of the product

FieldSmart® FiberFlex 2000

Installation Manual



Proprietary Notice

Information contained in this document is copyrighted by Clearfield, Inc. and may not be duplicated in full or part by any person without prior written approval of Clearfield, Inc.

Its purpose is to provide the user with adequately detailed documentation to efficiently install the equipment supplied. Every effort has been made to keep the information contained in this document current and accurate as of the date of publication or revision.

However, no guarantee is given or implied that the document is error free or that it is accurate with regard to any specification.

Technical Support

Clearfield, Inc. can be contacted for any issues that arise with the supplied product.

If you need to return the supplied product, you must contact the Clearfield, Inc. Customer Service Department to request a Returned Materials Authorization (RMA) number.

Clearfield, Inc.
7050 Winnetka Ave N
Minneapolis, MN 55428

Toll Free: 800.422.2537
Phone: 763.476.6866
Fax: 763.475.8457

Customer Support: sales@clfd.net
Technical Support: techsupport@clfd.net