

StreetSmart Pre-Terminated FDH Cabinet

Installation Manual



CLEARFIELD



StreetSmart Pre-Terminated FDH Cabinet

Installation Manual



Table of Contents

Application	3
Description	3
Technical Specifications	3
Mounting Base to Vault Lid	4
Mounting Cabinet to Base	6
Pole Mount Installation	7
Pre-Loaded Splitters	10
Connector Cleaning Procedure	11
Standard Warranty	16
Proprietary Notice	17
Technical Support	17



StreetSmart Pre-Terminated FDH Cabinet

Installation Manual

Application

Clearfield's StreetSmart Pre-Assigned FDH PON Cabinet provides an interconnect environment from the feeder network through the passive optical splitter to the distribution network.

Designed for rapid PON Network deployments, these cabinets provide a single distribution point to deploy FTTH in large scale MDU's, urban or dense neighborhoods. Pre-Assigned WaveSmart High Density 1 x 32 Splitters are loaded into the cabinet with a pre-terminated fiber tail, making installation and deployment very cost and time effective.

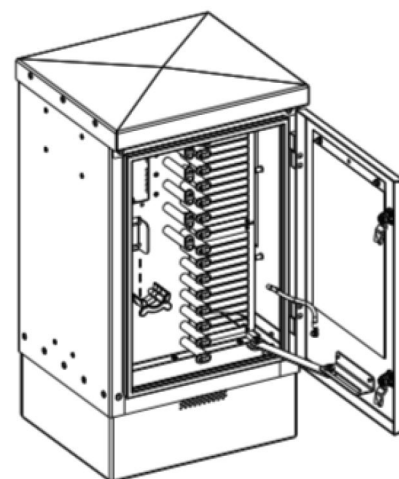

Description

The StreetSmart Pre-Assigned FDH PON Cabinet provides a turn-key solution for up to 288 distribution fibers for an outside plant FTTx PON application. WaveSmart High Density 1 x 32 Splitters are installed and pre-assigned into Clearfield's 12 pack SC/APC module adapters, allowing the service provider to instantly turn-up revenue-generating circuits.

The StreetSmart 288 PON Cabinet incorporates a cross-cut roof designed to shed water and includes a roof/solar shield and a reusable/replaceable venting feature, providing additional protection for deployed fiber. The outer shell of the cabinet is replaceable, allowing the cabinet to be repaired if damaged. Mounting options include pad, pole or vault mounted with either a 6" or 12" riser.

Technical Specifications

StreetSmart Pre-Terminated FDH Cabinet	
Dimensions	22.72" T x 15.47" W x 14.18" D (577.08mm T x 393.94mm W x 360.17mm D) * Without Riser
Weight	40 lbs. (18.14 kg)
Dist. Port Density	144 or 288
Max. Feeder/Express Ports	12 or 24
Cable Entrances	4
Mounting Options (Hoist kits included with each cabinet)	Vault mount; pole mount; pad mount
Riser Base	6"; 8 lbs (127 mm; 2.72 kg) 12"; 12 lbs. (304.80 mm; 5.44 kg)
Pre-loaded WaveSmart High Density Splitters with 900um Legs	4 or 8
Splitter Staging Capacity	72
Connector Modules	12 Pack Adapter Modules
Connector Types	SC/UPC, SC/APC
Cable Types	Indoor/Outdoor, Outdoor, Outdoor Armored, Ribbon and Loose Tube
Door Locks	2 per door
Venting	Built-in Replaceable Roof Vent
Material	0.90 (2.286 mm) Aluminum with almond powder coating

StreetSmart Pre-Terminated FDH Cabinet

Installation Manual



Mounting Base to Vault Lid

1. Remove the access door from the back of the cabinet base with a 7/16" socket or can wrench.



2. Remove the nuts from the threaded studs holding the cabinet to the base and lift the cabinet from the base.



3. Place the cabinet base over the hole in the vault lid.



4. Place the rectangular washer plates over the round cutouts in the cabinet base.



5. Insert the J-bolts through the base of the rectangular washer plates, ensuring that the J hook is hooked under a rib of the vault lid underneath.



6. Using the washers, lock washers, and nuts provided, secure the cabinet vase to the vault lid.

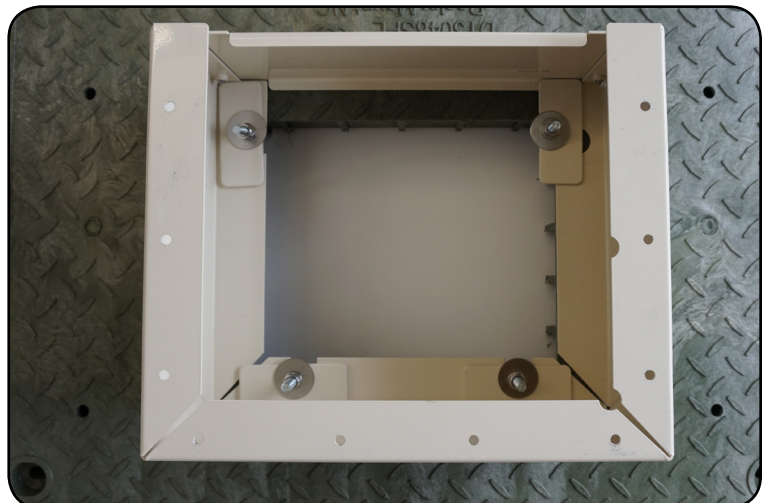

StreetSmart Pre-Terminated FDH Cabinet

Installation Manual



Mounting Cabinet to Base

1. Feed the cables through the cabinet base and vault lid as you lower the cabinet onto the base. Carefully align all the threaded studs on the bottom of the cabinet with the holes in the top of the base as you seat it into place.



2. Using the provided washers and nuts, firmly secure the cabinet to the base.



3. Reinstall the base access door





StreetSmart Pre-Terminated FDH Cabinet

Installation Manual

Pole Mount Installation

Note: Clearfield does not provide the mounting hardware. Required hardware includes a 5/8" threaded rod (3" longer than pole diameter), washers, lock washers, nuts and Lock Tight (red).

Note: 288 PON FSC cabinet shown for reference. Pre-Terminated FDH cabinet will be mounted to the pole using the same method.

1. Locate the hoist plate and install, using the included hardware, to the top of the cabinet on the side that will be closest to the pole.



2. Locate the toothed bracket that has the mounting holes in the flange and mount it to the cabinet (below the previously installed hoist plate) using the included hardware.



3. Determine the top height of the cabinet. Drill a 5/8" hole 8 inches below the anticipated height of the cabinet, all the way through the pole.

StreetSmart Pre-Terminated FDH Cabinet

Installation Manual



4. Mount the loose toothed bracket to the pole using threaded rod, washers and nuts on either side of the pole. Rod length will depend on the diameter of the pole. It is suggested to add 3" to the diameter of pole for rod length.



Note: Clearfield does not recommend using lag bolts to mount cabinet to pole. Clearfield recommends using hardware with a minimum of 5/8" diameter. Care should be taken to avoid over-tightening and deforming the hoist plate. Lock tight (red) should be used on nuts to prevent loosening of nuts. Make sure the thread rod/nut does not exceed the top bend in bracket or it will interfere with cabinet.

5. Lower the cabinet onto the pole mounted toothed bracket until the hoist plate is over the flange of the toothed bracket.



- Level cabinet and drill 5/8" hole through lower bracket and pole, and install 5/8" rod, washers and nuts.



Note: Care should be taken to avoid over-tightening and deforming the hoist plate.

- Cabinet Fully Mounted



StreetSmart Pre-Terminated FDH Cabinet

Installation Manual



Pre-Loaded Splitters

The StreetSmart Pre-Terminated FDH Cabinet will come with 1x32 WaveSmart HD Splitters pre-installed. Splitter 1's feeder leg will be connected to feeder port 1, and its distribution legs will be connected to distribution ports 1-32. Splitter 2 will connect to feeder port 2, and distribution ports 33-64, and so on, for the number of splitters pre-installed in the ordered configuration.

If you wish to pull service from a pre-installed splitter leg, the connector can be installed into one of the adapters in the provided staging plates.

Note: Splitter legs will be secured in place with a velcro strap around the radius fingers.

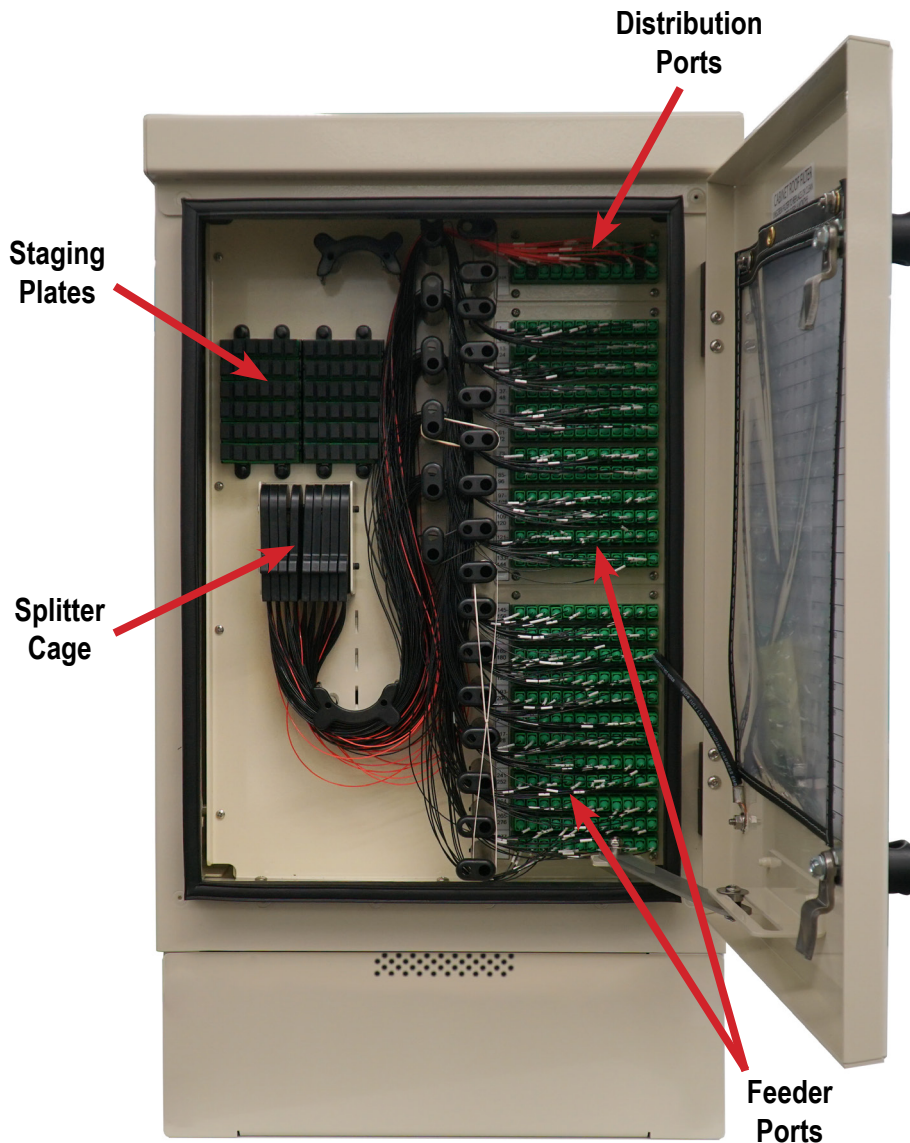

Connector Cleaning Procedure

Whether factory terminated or field spliced, clean connectors are essential for proper system operation. Even the smallest dust particle can cause transmission problems, so for optimal network performance inspect, and if necessary, clean connectors and adapters prior to mating.

Inspect Then Connect

These are Clearfield recommended products/applications. Use the product you feel will complete your cleaning procedures. Create a “best practice” for your company and follow those procedures.

The use of Chemtronics end face and bulkhead cleaning products and techniques ensures a clean end face, no matter the type of contamination.

Before cleaning any connector, be sure you know what type of contaminate you are cleaning (dry, fluidic, or combination). All the available products are good, it's the process that you need to be aware of. Using a dry cleaning method to clean “dirt” can lead to scratching of the end face. Learn the process of cleaning properly.

Note: It is **NOT** recommended to use isopropyl alcohol to clean the end face.

Cleaning an SC/LC Connector

Cleaning the End Face

- Place one wiping paper on QbE-2 FiberSafe™ Cleaning Platen. (Figure 1)
- Apply small amount of precision cleaner (about 1” in diameter) with Electro-Wash MX pen on to one end of the wipe. (Figure 2)
- Hold end face at a 90 degree angle. For APC connection, adjust by slightly tilting the container or end face. Angle is correct when no drag is felt on the end face. (Figure 3)
- Draw end face from wet to dry part of the wipe 3 times. Use just enough pressure to ensure complete contact between end face and the wipe.

Note: **DO NOT** retrace previous step.



Figure 1



Figure 2



Figure 3

Cleaning the Ferrule

- Lightly moisten the fiber optic swab (2.5mm/38542F or 1.25mm/38040) by spotting a small amount (about 1") of Electro-Wash PX or Electro-Wash MX pen onto the QbE. Hold the swab, 1 side down to the wetted area and hold for a count of 1-2-3-4-5. (Figure 4)

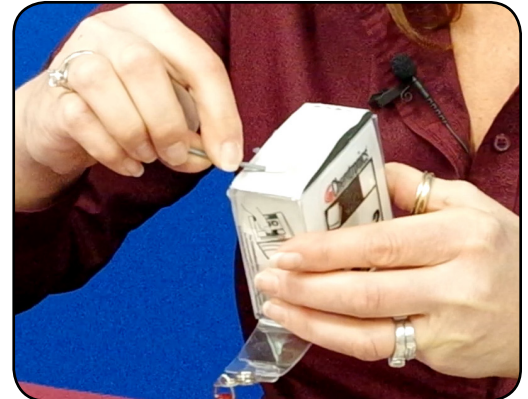

Figure 4

- Insert swab into side of ferrule, wet side to the ceramic ferrule and circle around 2-3 times and remove. Turn swab to dry side and repeat. (Figure 5)



Figure 5

Cleaning the Mate Through an Adapter AND the Adapter Itself

- Lightly moisten the fiber optic swab (2.5mm/38542F or 1.25mm/38040) by spotting a small amount (about 1") of Electro-Wash PX or Electro-Wash MX pen onto the QbE. Hold the tip of the swab onto the wetted area and hold for a count of 1-2-3-4-5.
- Insert the swab into the adapter to the connector, press lightly against the connector, twist 2-3 times, remove and discard.
- Dry with a second dry swab.
- Inspect, repeat cleaning if necessary, and test for signal strength.
- Use additional swabs to clean inside the actual adapter. Moisten swab, like above, and insert through hole and remove while twisting. (Figure 6)

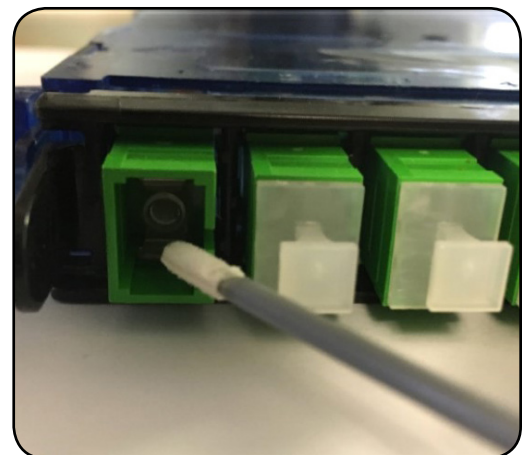
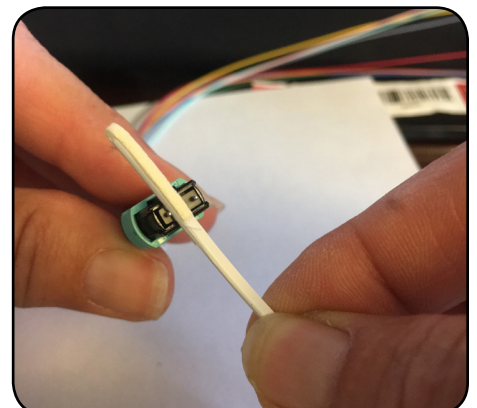

Figure 6

Cleaning an MPO/MTP Connector

Male Connector

- Use of Chemtronics MTP Connector Cleaning Swabs (CC505F) is recommended. Even after cleaning with a probe cleaner, you should always clean the pins with this (or an equivalent) type swab. Cleans ALL MTP/MPO connector end faces. This swab also cleans the “pins” of the male connector
- Lightly “spot” a QbE-2 wipe on the platen with Electro-Wash PX Fiber Optic Cleaner, the FiberWash or MX Pen.
- Lightly touch short side of the MTP/MPO Connector Swab to the wetted area (3-5 secs) to absorb some cleaning solution (DO NOT over saturate the swab).
- Wipe connector areas to be cleaned, sliding pad from bottom of pad across and forward to tip of swab, from 1 side to the other, turn over and use long side to dry in same movement.



- Use the hole on end of pad to clean one alignment pin, then press the end of the swab into the other pin to clean.
- Check your work with a fiber scope. This can take several attempts to get the endface clean.

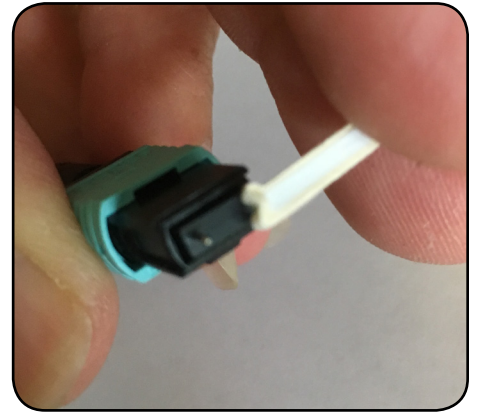
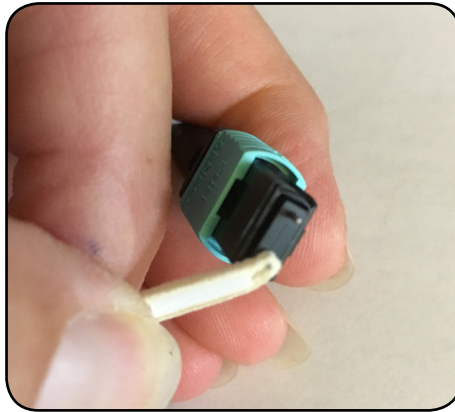

Female Connector (without pins)

- Cleaned like a single fiber connector, using a cleaning platform. The receptacles will be cleaned as long as you are using a combination cleaning process as recommended.
- Again, using a platen, moisten the platen with cleaning solvent on one end to accommodate 3 swipes of the MPO female endface.

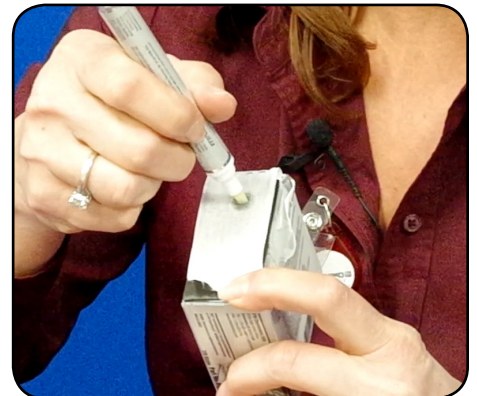

- Holding the connector (If APC, slightly at an angle to accommodate for 8° angle) swiping with medium pressure, from the wet area into the dry area 3 times, without wiping over previous area.
- Inspect, and if clean, make the connection. If NOT, repeat above steps until clean or if determined that the end face is damaged (based on standards of 5 cleanings per connection), replace.

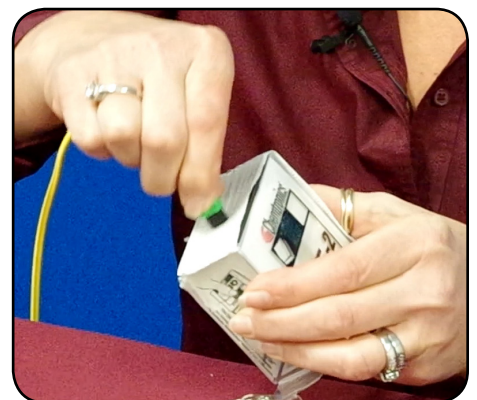

Cleaning Using a Probe-Style Cleaning Tool

- The probe style cleaning tools are capable of cleaning a connector end face separately or through the adapter.
- Slightly engage probe by pulling back but do not allow to click. Lightly “spot” a QbE-2 wipe on the platen with Electro-Wash PX Fiber Optic Cleaner, this will help alleviate “over saturation” of the material.
- Lightly touch the tip of probe and release.

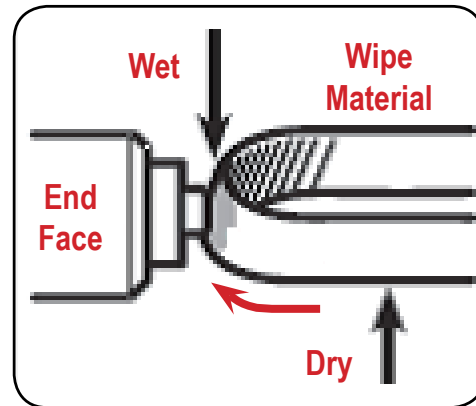

- Insert connector or insert probe through adapter and click 2-3 times to move past the wet area and allow material to dry wipe.

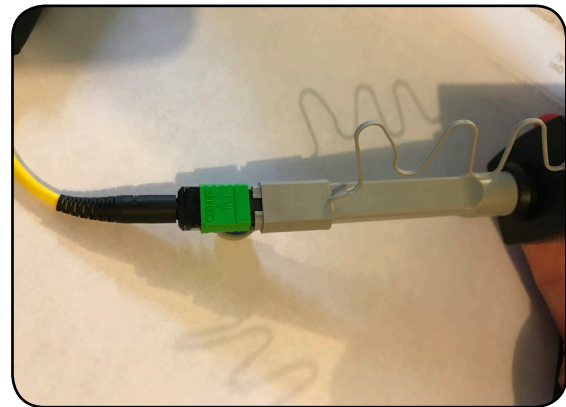

- Inspect connector, repeat if necessary (following standards)
- If cleaning a male connector, clean the pins (see above)

StreetSmart Pre-Terminated FDH Cabinet

Installation Manual



Standard Warranty

Clearfield warrants to the original purchaser of the Product sold hereunder is free from defects in material and workmanship under normal use and service, subject to exceptions stated herein. Product purchased is warranted as follows: Clearfield designed and branded Products are warranted for three (3) years; Products manufactured by Clearfield to customer prints and/or specifications are warranted for one (1) year; and any Product Clearfield acquires from or through a third-party manufacturer or distributor and resells to Customer as the original customer will carry the manufacturer's pass-through warranty, if any. In all cases, the warranty period commences on the date of shipment to the original purchaser.

Warranty Claim Procedure

If any Product purchased from Clearfield is found defective under the above warranty, the following basic procedure must be followed:

1. Customer must contact Clearfield and obtain a Return Materials Authorization
2. Following authorization, the Customer ships the product-freight collect to Clearfield's manufacturing facility
3. Clearfield shall repair or replace the defective Product at its sole option and discretion, and return the repaired or replacement Product to Customer's site, freight prepaid

Note: If the Product is not found to be defective by Clearfield, the product will be returned to the Customer and the customer billed for freight in both directions.

View our warranty policy here: <https://www.seeclearfield.com/warranty.html>

Limitations of Warranty

Correction of defects by repair or replacement, at the option of Clearfield Inc, shall constitute the exclusive sole remedy for a breach of this limited warranty. Clearfield shall not be liable under any circumstances for any special, consequential, incidental, punitive, or exemplary damages arising out of or in any way connected with the product or with agreement to sell product to buyer, including, but not limited to damages for lost profits, loss of use, or for any damages or sums paid by buyer to third parties. The foregoing limitation of liability shall apply whether the claim is based upon principles of contract, warranty, negligence or other tort, breach of statutory duty, principles of indemnity or contribution, the failure of any limited or exclusive remedy to achieve its essential purpose, or otherwise.

Clearfield will not be responsible for any labor or materials costs associated with installation or incorporation of Clearfield products at customer sites, including any costs of alteration, replacement or defective product, or any field repairs.

Other Limitations

Clearfield assumes no warranty liability regarding defects caused by:

1. Customer's modification of Product, excepting installation activities described in Clearfield documentation
2. Customer re-packaging of Product for shipment to third parties or destinations other than those originally shipped to by Clearfield, or any defects suffered during shipping where the Product has been re-packaged
3. Customer's installation or maintenance, excepting activities described in and performed in accordance with Clearfield documentation
4. Customer's improper or negligent use or application of Product
5. Other causes external to the Product, including but not limited to accidents, catastrophe, acts of God, government action, war, riot, strikes, civil commotion, sovereign conduct, or the acts or conduct of any person or persons not party to or associated with Clearfield
6. Environmental factors and weathering resulting in aging and damage not necessary or applicable to the function of the product



StreetSmart Pre-Terminated FDH Cabinet

Installation Manual

Proprietary Notice

Information contained in this document is copyrighted by Clearfield, Inc. and may not be duplicated in full or part by any person without prior written approval of Clearfield, Inc.

Its purpose is to provide the user with adequately detailed documentation to efficiently install the equipment supplied. Every effort has been made to keep the information contained in this document current and accurate as of the date of publication or revision.

However, no guarantee is given or implied that the document is error free or that it is accurate with regard to any specification.

Technical Support

Clearfield, Inc. can be contacted for any issues that arise with the supplied product.

If you need to return the supplied product, you must contact the Clearfield, Inc. Customer Service Department to request a Returned Materials Authorization (RMA) number.

Clearfield, Inc.
7050 Winnetka Ave N
Minneapolis, MN 55428

Toll Free: 800.422.2537
Phone: 763.476.6866
Fax: 763.475.8457

Customer Support: sales@seeclearfield.com
Technical Support: techsupport@seeclearfield.com